

DENON[®]

DCD-800NE

COMPACT DISC PLAYER

Owner's Manual

You can print more than one page of a PDF onto a single sheet of paper.

[Front panel](#)[Display](#)[Rear panel](#)[Remote](#)[Index](#)

Accessories	4
Inserting the batteries	5
Operating range of the remote control unit	5
Features	6
High quality sound	6
High performance	6
Part names and functions	7
Front panel	7
Display	9
Rear panel	10
Remote control unit	11

Connections

Connecting an amplifier	18
Connecting to a device with digital audio input connectors	19
Connecting a USB memory device to the USB port	20
Connecting the timer device	21
Connecting the power cord	22

Playback

Basic operation	24
Turning the power on	24
Switching the power to standby	24
Selecting the media mode	25
Switching the display's brightness	25
Switching the Pure Direct mode	26
Playing CDs	27
Playing CDs	27
Playing tracks in a specific order (Program playback)	29
Playing DATA CDs	30
Playing files	31
Playing a USB memory device	33
Playing files stored on USB memory devices	34
Using the timer play function	36



Settings

Setting the Auto Standby mode	37
Turning Auto Standby mode on	37
Turning Auto Standby mode off	37

Tips

Tips	39
Troubleshooting	40
Power does not turn on / Power is turned off	41
Operations cannot be performed through the remote control unit	42
Display on this unit shows nothing	42
No sound comes out	43
Sound is interrupted or noise occurs	43
Cannot playback Discs	44

Appendix





Playing back Discs	45
Files	45
Playing back a USB memory devices	47
Playback order of files	49
About folders and files	49
Cautions on using media	50
Loading discs	50
How to handle media	51
Cleaning discs	51
Explanation of terms	52
Trademark information	54
Specifications	55
Index	58

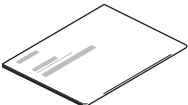
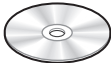

Thank you for purchasing this Denon product. To ensure proper operation, please read this owner's manual carefully before using the product. After reading this manual, be sure to keep it for future reference.

Accessories

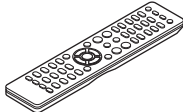
Check that the following parts are supplied with the product.

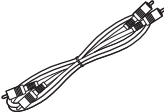
 Quick Start Guide	 CD-ROM (Owner's Manual)	 Safety Instructions	 Warranty (for North America model only)
 Remote control unit (RC-1223)	 R03/AAA batteries	 Audio cable	



Inserting the batteries

- 1 Remove the rear lid in the direction of the arrow and remove it.



- 2 Insert two batteries correctly into the battery compartment as indicated.

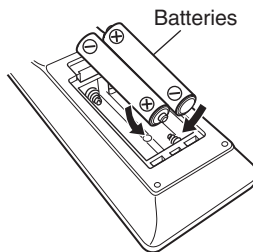

- 3 Put the rear cover back on.

NOTE

- To prevent damage or leakage of battery fluid:
 - Do not use a new battery together with an old one.
 - Do not use two different types of batteries.
- Remove the batteries from the remote control unit if it will not be in use for long periods.
- If the battery fluid should leak, carefully wipe the fluid off the inside of the battery compartment and insert new batteries.

Operating range of the remote control unit

Point the remote control unit at the remote sensor when operating it.

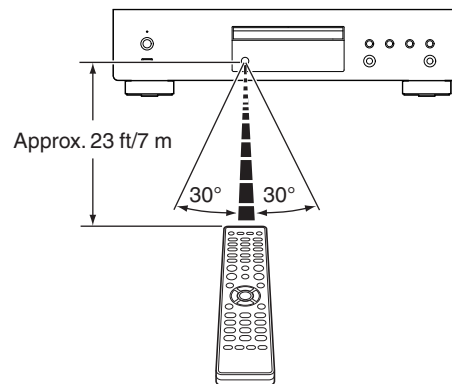

Features

High quality sound

- **High Bitrate and High Sampling with Advanced AL32 Processing Plus**

A high bitrate and high sampling has been achieved with Denon's unique data interpolation algorithm. 16 bit audio signals are converted to a high bitrate of 32 bit and 44.1 kHz sampling signals are up-sampled by 16x to achieve smoother recreation of sound waves. Data interpolation is also used, predicting interpolation points from a large number of surrounding points to provide audio as close as possible to the original sound. This elaborate restoration of data lost during digital recording achieves fine, distortion-free rendering, accurate sound localizing, rich bass and recreation that is faithful to the original sound.

- **DAC Master Clock Design for the Ideal Clock**

To make full use of the properties of this unit's semiconductor, it was important to use a highly accurate clock signal for the semiconductor's operations. This model contains 2 oscillators, one for each frequency. These oscillators are developed to dramatically decrease phase noise caused by frequency displacement, achieving a more stable and more accurate clock than ever before. The master clock is near the D/A converter, reducing jittering to achieve faithful playback.

High performance

- **Supports MP3 and WMA file playback** (see p. 30)

MP3 and WMA files that have been recorded onto CD-R or CD-RW discs can be played back on this CD player.

- **Plays USB memory devices (MP3/WMA/AAC/WAV/FLAC/Apple Lossless/AIFF/DSD).**

You can play back audio files stored on a USB memory device by connecting the USB memory device to the USB port.

- **Reduced power consumption during standby**

The power consumption in standby mode has been reduced to below 0.2 W in consideration of the environment.



Part names and functions

Front panel

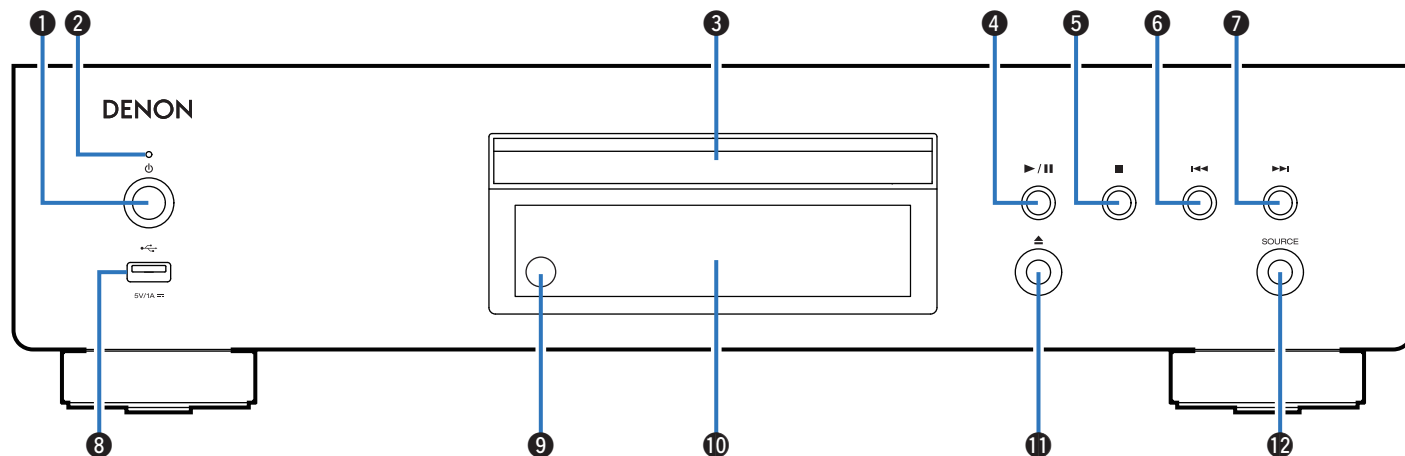

1 Power operation button (⏻)

This turns the power on/off. (📖 p. 24)

2 Power indicator

This is lit as follows according to the power status:

- Power on : Green
- Standby : Off
- Power off : Off

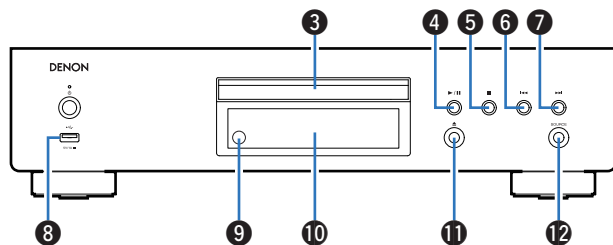

**3 Disc tray**

Used to insert a disc.

4 Play/pause button (▶/||)

Plays the track/Pauses the track.

5 Stop button (■)

Stops playback.

6 Reverse-skip button (◀◀)

Returns to the start of the currently playing track.

7 Forward-skip button (▶▶)

Plays the next track.

8 USB port (🔌)

This is used to connect USB storages (such as USB memory devices).
(🔗 p. 20)

9 Remote control sensor

This receives signals from the remote control unit. (🔗 p. 5)

10 Display

Various information is displayed here. (🔗 p. 9)

11 Disc tray open/close button (▲)

Used to open/close the disc tray.

12 SOURCE button

Select the media to play back. (🔗 p. 25)



Display

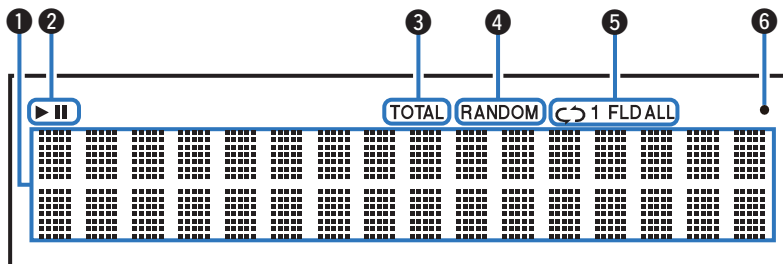

1 Information display

Displays various information or playback elapsed time and so on of the disc.

2 Playback mode indicators

▶ : Lights up during playback.

|| : Lights up during pause.

3 TOTAL indicator

Lights when the total number of tracks and total time of the CD are displayed.

4 RANDOM indicator

Lights during random playback.

5 Repeat mode indicators

Lights to match the repeat mode settings.

6 Remote control signal reception indicator

Lights when a signal is received from the remote control.



Rear panel

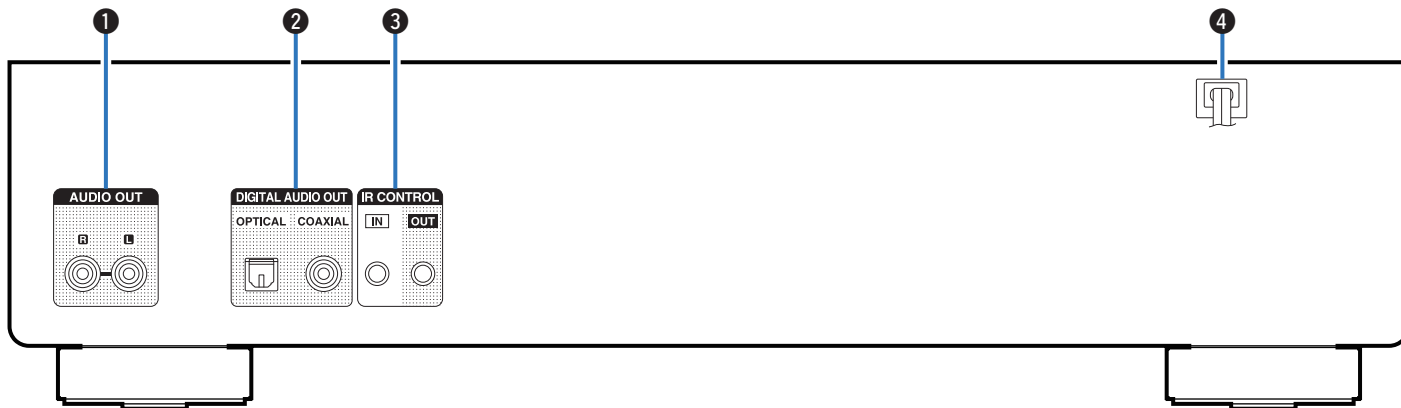

1 AUDIO OUT connectors

Used to connect devices equipped with analog audio inputs connectors or an external power amplifier. (👉 p. 18)

2 DIGITAL AUDIO OUT connectors

Used to connect an AV receiver or D/A converter that has a digital input connectors. (👉 p. 19)

3 IR CONTROL connectors

Used to connect Denon network audio players with an IR controller.

4 Power cord (👉 p. 22)



Remote control unit

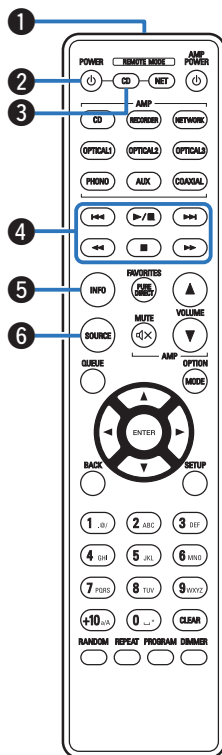

The included remote control can be used to operate not only this unit but other Denon amplifiers and network audio players too.

- “Amplifier operations” (📖 p. 14)
- “Network audio player operations” (📖 p. 15)

■ Operating this unit

To operate CD player, press REMOTE MODE CD button to switch the remote control to the CD player operation mode.

1 Remote control signal transmitter

This transmits signals from the remote control unit. (📖 p. 5)

2 Power operation button (POWER ⏻)

This turns the power on/off (standby). (📖 p. 24)

3 Remote mode select button (REMOTE MODE CD)

This switches the remote control to the CD player operation mode.

4 System buttons

These perform playback related operations.

5 Information button (INFO)

This switches the track information shown in the display during playback.

6 SOURCE button

Select the media to play back. (📖 p. 25)



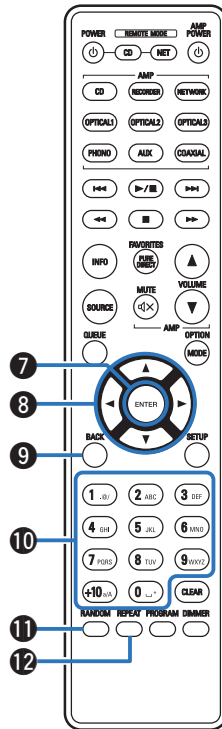

7 ENTER button

This determines the selection.

8 Cursor buttons (Δ ∇ \triangleleft \triangleright)

These select items.

9 BACK button

Returns to the previous item.

10 Number/letter buttons (0 – 9, +10)

These enter letters or numbers into the unit.

11 RANDOM button

Switches the random playback.

12 REPEAT button

Switches to the repeat playback.



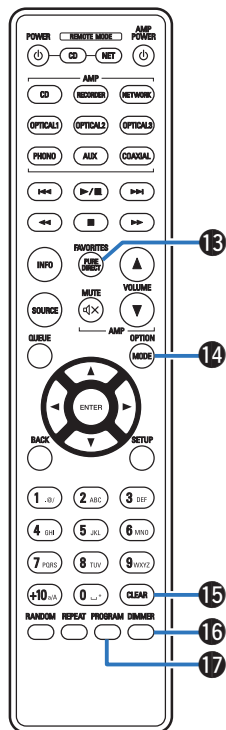

13 PURE DIRECT button

Switches the Pure Direct mode. (☞ p. 26)

14 MODE button

- Selects the playback range of the data CD. (☞ p. 32)
- Selects the playback range of the USB memory. (☞ p. 35)

15 CLEAR button

This clears the program registration. (☞ p. 29)

16 DIMMER button

This switches the brightness of the display. (☞ p. 25)

17 PROGRAM button

This sets program playback. (☞ p. 29)



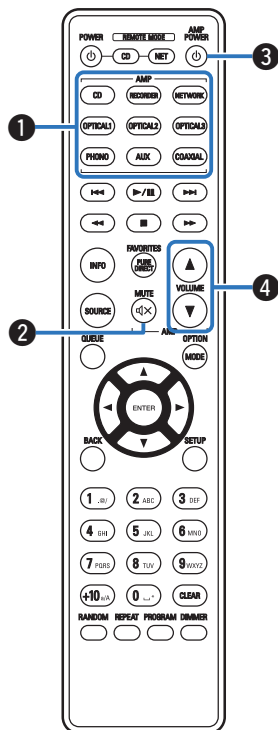

■ Amplifier operations

A Denon amplifier can be operated.

- ① Input source select buttons
- ② MUTE button (🔇)
- ③ Power operation button (AMP POWER ⏻)
- ④ VOLUME buttons (▲▼)



- The remote control may not operate some products.



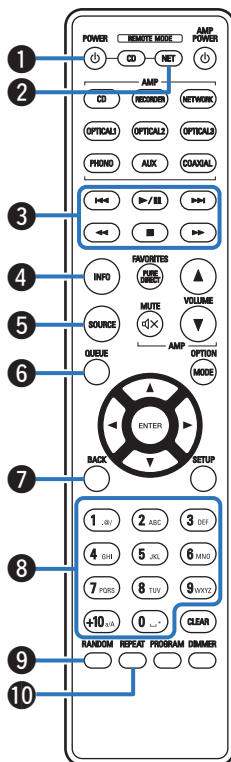

■ Network audio player operations

You can operate a Denon network audio player.

To operate a Denon network audio player, press the REMOTE MODE NET button to switch the remote control to the network audio player operation mode.

- 1** Power operation button (POWER ϕ)
- 2** Remote mode select button (REMOTE MODE NET)
- 3** System buttons
- 4** Information button (INFO)
- 5** SOURCE button
- 6** QUEUE button
- 7** BACK button
- 8** Number/letter buttons (0 – 9, +10)
- 9** RANDOM button
- 10** REPEAT button



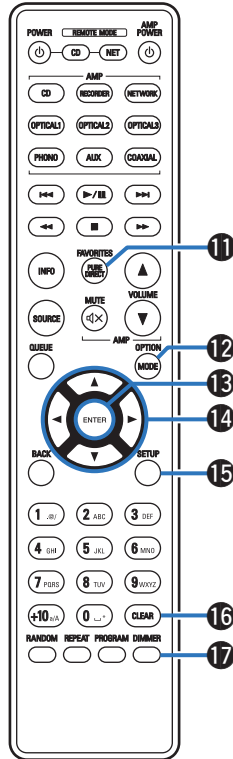

- 11 FAVORITES button
- 12 OPTION button
- 13 ENTER button
- 14 Cursor buttons (Δ∇◀▶)
- 15 SETUP button
- 16 CLEAR button
- 17 DIMMER button



- The remote control may not operate some products.



■ Contents

Connecting an amplifier	18
Connecting to a device with digital audio input connectors	19
Connecting a USB memory device to the USB port	20
Connecting the timer device	21
Connecting the power cord	22

NOTE

- Do not plug in the power cord until all connections have been completed.
- Do not bundle power cords together with connection cables. Doing so can result in humming or noise.

■ Cables used for connections

Provide necessary cables according to the devices you want to connect.

Audio cable
(supplied)



Optical cable
(Sold separately)



Coaxial digital cable
(Sold separately)



Connecting an amplifier

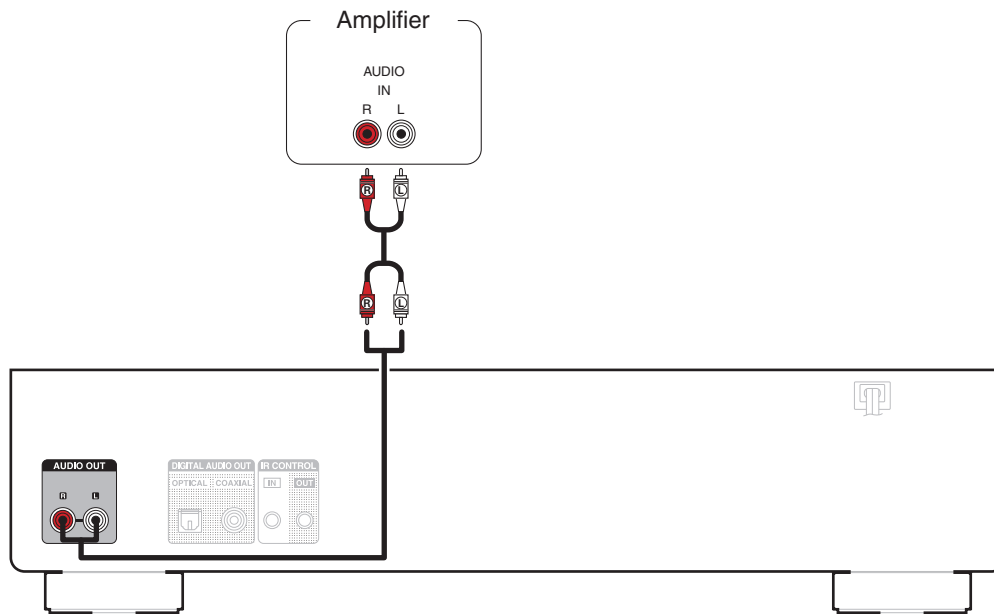

Connecting to a device with digital audio input connectors

You can enjoy digital audio playback by connecting an AV receiver or D/A converter that has a digital audio terminal to this unit.

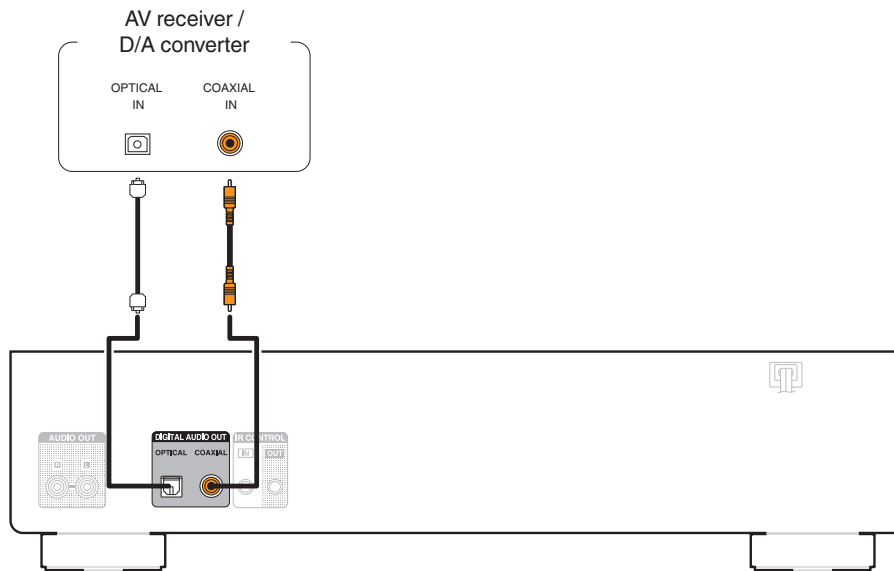

NOTE

- Digital audio output stops during playback of the DSD files.



Connecting a USB memory device to the USB port

For operating instructions see “Playing a USB memory device”. (🔍 p. 33)

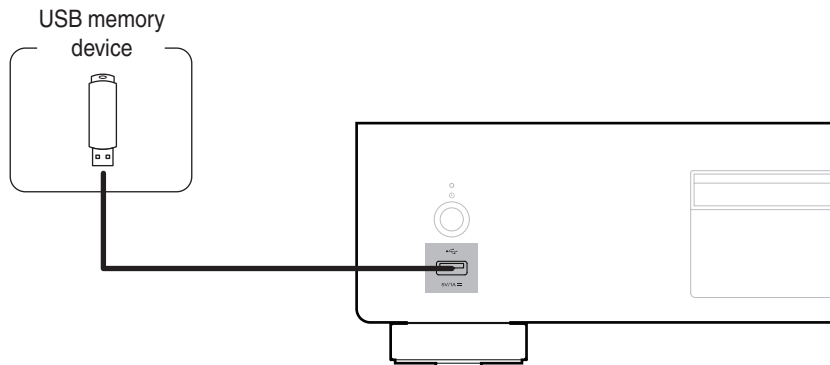

- Denon does not guarantee that all USB memory devices will operate or receive power. When using a portable USB hard disk drive (HDD) which came with an AC adapter, use that device's supplied AC adapter.

NOTE

- USB memory devices will not work via a USB hub.
- It is not possible to use this unit by connecting the unit's USB port to a PC via a USB cable.
- Do not use an extension cable when connecting a USB memory device. This may cause radio interference with other devices.



Connecting the timer device

This unit can perform timer play when an amplifier and timer device are connected to this unit. (“Using the timer play function” (📖 p. 36))

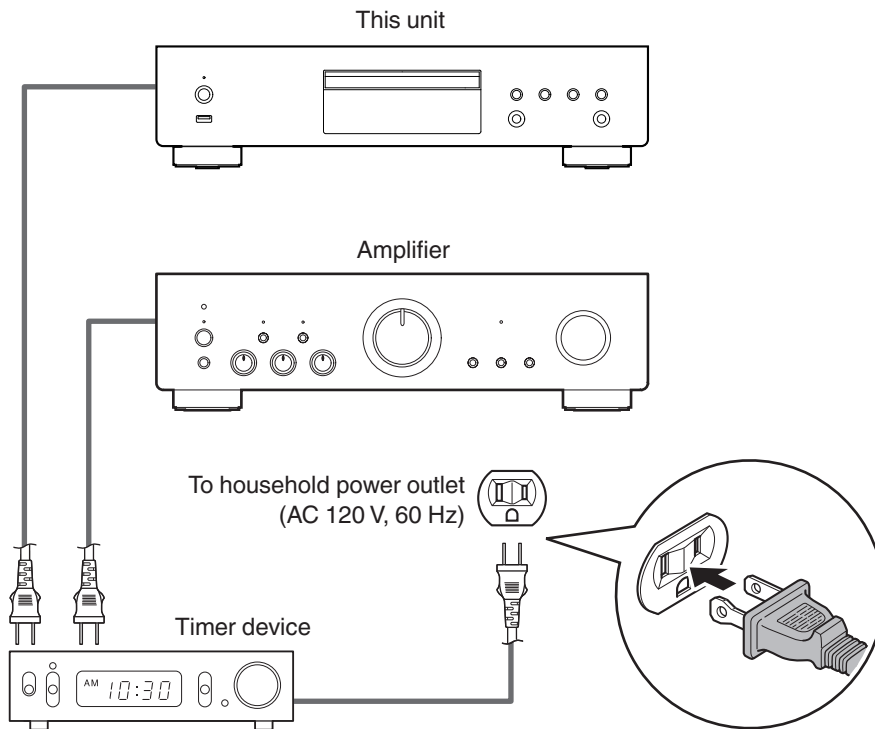

Connecting the power cord

After completing all the connections, insert the power plug into the power outlet.

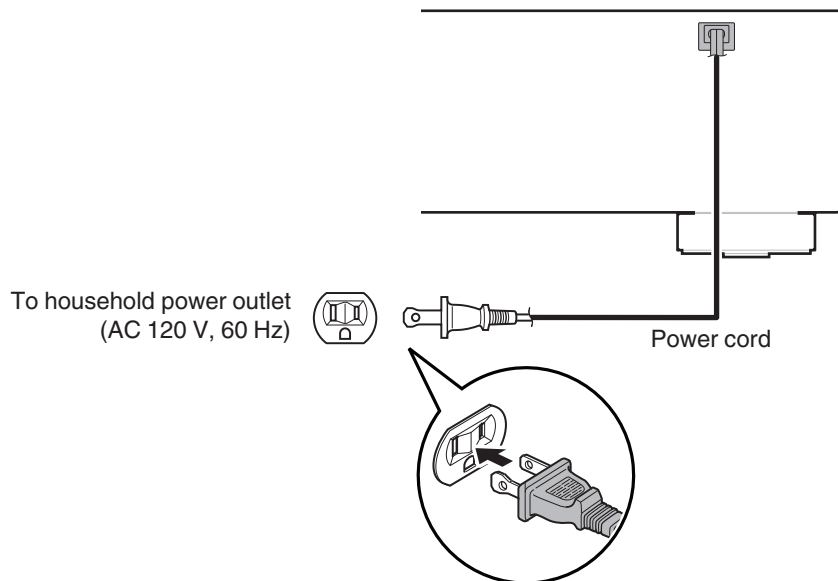

■ Contents

Basic operation	24
Playing CDs	27
Playing DATA CDs	30
Playing a USB memory device	33
Using the timer play function	36



Basic operation

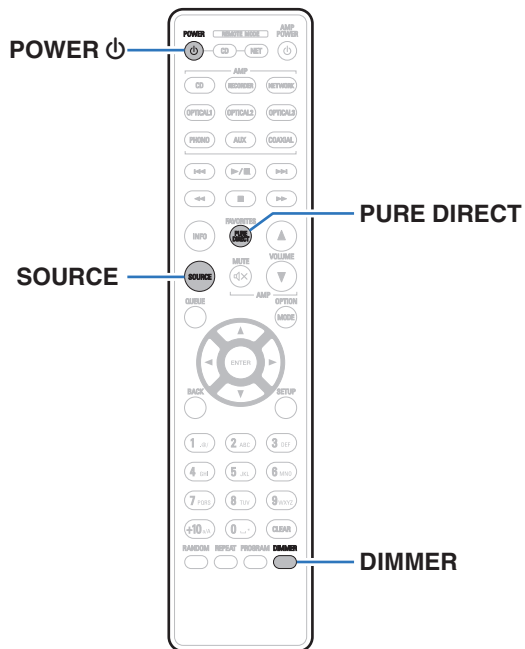

Turning the power on

- 1 Press ϕ on the main unit to turn the power on.
The power indicator lights green.



- Press POWER ϕ on the remote control unit to turn on power from standby mode.

Switching the power to standby

- 1 Press POWER ϕ .
The unit switches to standby mode.

NOTE

- Power continues to be supplied to some of the circuitry even when the power is in the standby mode. When leaving home for long periods of time or when going on vacation, either press ϕ on the main unit to turn off the power, or unplug the power cord from the power outlet.



Selecting the media mode

1 Press SOURCE to select the media mode to play back.

The selected media mode is shown in the display.

DISC / USB(Default: DISC)



- You can also select the playback media mode by pressing SOURCE on the unit.

Switching the display's brightness

The display brightness can be adjusted between four levels. Switching the display off reduces a source of noise that affects sound quality, enabling higher sound quality playback.

1 Press DIMMER.

- The brightness of the display switches each time the button is pressed.



- The display brightness is set to most brightly by default.
- Press and hold DIMMER for more than 2 seconds to return the display brightness to the default setting.



Switching the Pure Direct mode

In Pure Direct mode, the display turns off and digital audio output stops. This reduces the source of noise that can adversely affect sound quality, enabling high quality playback.

1 Press PURE DIRECT.

The display turned off, and Pure Direct playback begins.

- Switches the Pure Direct mode each time the button is pressed.

PURE DIRECT ON MODE1:	Turns off the display and outputs digital audio.
PURE DIRECT ON MODE2:	Turns off the display and stops output of digital audio.
PURE DIRECT OFF (Default):	Disables Pure Direct mode.

NOTE

- The display brightness cannot be changed in Pure Direct mode.
- The display is only turned off during playback.



Playing CDs

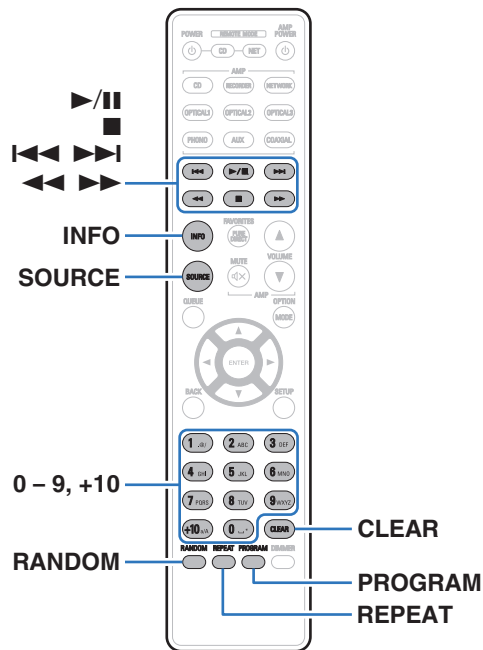

Playing CDs





- 1 **Insert a disc.** (👉 p. 50)
 - Press **▲** on the unit to open/close the disc tray.
- 2 **Press SOURCE to change the playback media mode to “DISC”.** (👉 p. 25)
- 3 **Press ►/||.**

The ► indicator lights on the display. Playback starts.

NOTE

- Do not place any foreign objects in the disc tray. Doing so could damage the unit.
- Do not push the disc tray in by hand when the power is turned off. Doing so could damage the unit.



Operation buttons	Function
	Playback / Pause
	Stop
	Skip to previous track / Skip to next track
	Fast-reverse / Fast-forward
0 - 9, +10	Select the track
RANDOM	Random playback <ul style="list-style-type: none"> The random playback function only works in stop mode.
REPEAT	Repeat playback <ul style="list-style-type: none"> Switching between All-track repeat and Single-track repeat.
INFO	Time display switching <ul style="list-style-type: none"> Switching between elapsed time of the current track, remaining time of the current track and remaining time of all tracks. The time displayed on this unit may differ from this actual time, as it is calculated by truncating to the nearest 1 second.

■ Discs that can be played back

- See "About Playing Back Discs". (📖 p. 45)

■ Playing a specific track (Direct searching)

1 Use 0 - 9, +10 to select the tracks.

[Example]

Track 4 :

Press number 4 to select track 4.

Track 12 :

Press numbers +10 and 2 consecutively.



Playing tracks in a specific order (Program playback)

Up to 25 tracks can be programmed.

1 In the stop mode, press PROGRAM.

“PGM” appears on the display.

2 Use 0 – 9 and +10 to select the tracks.

[Example]

To program tracks 3 and 12 to be played in that order, press 3, +10 and 2 one after the other.

3 Press ►/||.

Playback starts in the programmed order.



- When REPEAT is pressed during program playback, the tracks are played repeatedly in the programmed order.

■ Checking the order of the programmed tracks

In the stop mode, press ►►I.

The track numbers are displayed in the programmed order each time the button is pressed.

■ To clear the last track programmed

In the stop mode, press CLEAR.

The last track programmed is cleared each time the button is pressed.

■ Clearing the all programmed track

In the stop mode, press PROGRAM.



Playing DATA CDs

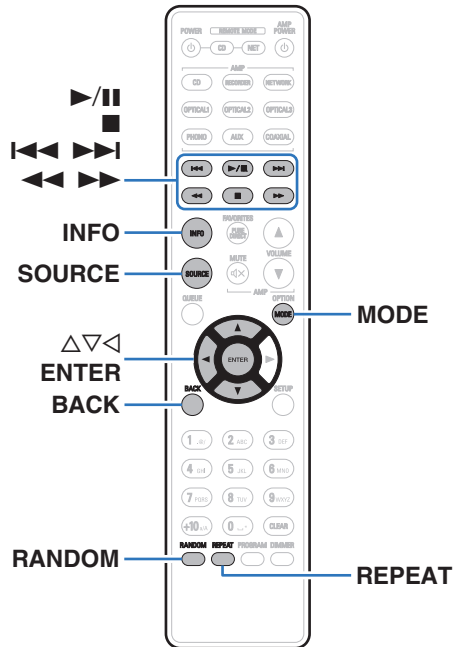

- This section explains how to playback music files that are recorded onto a CD-R or CD-RW.
- There are many music distribution sites on the Internet allowing you to download music files in MP3 or WMA (Windows Media® Audio) format. The music (files) downloaded from such sites can be stored on CD-R/-RW discs and played on this unit.
- The audio format types and specifications supported by this unit for playback are as follows.
See “Playable files” for details. (👉 p. 45)
 - MP3
 - WMA

NOTE





- Copyright-protected files cannot be played.
Note that depending on the software used for burning and other conditions, some files may not play or display correctly.

“Windows Media” and “Windows” are the trademarks or registered trademarks of Microsoft Corporation in the United States and other countries.



Playing files

- 1 Load a CD-R/-RW disc containing music files into the disc tray. (🔧 p. 50)
 - Press  on the unit to open/close the disc tray.
- 2 Press SOURCE to change the playback media mode to "DISC". (🔧 p. 25)
- 3 Use $\Delta \nabla$ to select the folder to be played, then press ENTER.
- 4 Use $\Delta \nabla$ to select the file to be played, then press ENTER.
Playback starts.

Operation buttons	Function
	Playback / Pause
	Stop
	Skip to previous track / Skip to next track
	Fast-reverse / Fast-forward
BACK	Moving up a level in the folder tree
$\Delta \nabla$	Select the item
ENTER	Enter the selected item / Playback
MODE	Select the playback range
RANDOM	Random playback <ul style="list-style-type: none"> • The random playback function only works in stop mode.
REPEAT	Repeat playback <ul style="list-style-type: none"> • Switching between All-track repeat and Single-track repeat.
INFO	Switches the display between Title name / Artist name, Title name / Album name and File name.



- To start playing another file during playback of a CD-R/CD-RW, first press \triangleleft to display the file tree. Next, use $\Delta \nabla$ to select the file to be played and press ENTER.



■ Switching the display

During playback, press INFO.

- Switches the display between Title name / Artist name, Title name / Album name and File name.
- If a file does not support text information or no track information is recorded, the file name is displayed.
- The player can display the following characters:

ABCDEFGHIJKLMNOPQRSTUVWXYZ

abcdefghijklmnopqrstuvwxyz

0123456789

!"#\$%&:;<>?@\[_`!{|}~^'()*+,-./= space

- The folder and file numbers are set automatically when the disc is loaded.

■ Switching the playback range

In the stop mode, press MODE.

- The playback range of a track can be set.

Folder mode: All the files in the selected folder are played.

All mode: All the files in the disc are played.



Playing a USB memory device

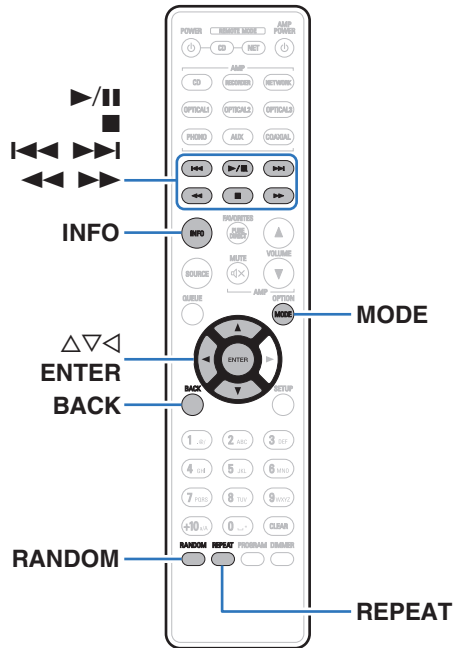

- Playing back music files stored on a USB memory device.
- Only USB memory devices conforming to mass storage class and MTP (Media Transfer Protocol) standards can be played on this unit.
- This unit is compatible with USB memory devices in “FAT16” or “FAT32” format.
- The audio format types and specifications supported by this unit for playback are as follows.
For details, see “Playing back a USB memory devices” (👉 p. 47).

- **WMA**
- **MP3**
- **WAV**
- **MPEG-4 AAC**
- **FLAC**
- **Apple Lossless**
- **AIFF**
- **DSD**



Playing files stored on USB memory devices





1 Insert the USB memory device into the USB port.

When you insert a USB memory device into the USB port, the media mode automatically switches to "USB".

2 Use $\Delta \nabla$ to select the folder to be played, then press ENTER.

3 Use $\Delta \nabla$ to select the file to be played, then press ENTER.

Playback starts.

Operation buttons	Function
	Playback / Pause
	Stop
	Skip to previous track / Skip to next track
	Fast-reverse / Fast-forward
BACK	Moving up a level in the folder tree
$\Delta \nabla$	Select the item
ENTER	Enter the selected item / Playback
MODE	Select the playback range
RANDOM	Random playback
	<ul style="list-style-type: none"> The random playback function only works in stop mode.
REPEAT	Repeat playback
	<ul style="list-style-type: none"> Switching between All-track repeat and Single-track repeat.
INFO	Switches the display between Title name / Artist name, Title name / Album name and File name.



- To start playing another file during playback of a USB memory device, first press \triangleleft to display the file tree. Next, use $\Delta \nabla$ to select the file to be played and press ENTER.



NOTE

- Note that Denon will accept no responsibility whatsoever for any problems arising with the data on a USB memory device when using this unit in conjunction with the USB memory device.
- All of the files can be read from a USB memory device by connecting the device to this unit. It may take time to read all of the files if there are a large number of files or folders on the USB memory device.

Switching the playback range

In the stop mode, press MODE.

- The playback range of a track can be set.

Folder mode:	All the files in the selected folder are played.
All mode:	All the files in the USB memory are played.



Using the timer play function

- 1 Turn on the power of the connected components.**
( p. 21)
- 2 Switch the amplifier's function to input from the connected unit.**
- 3 Insert a disc in the unit or insert a USB memory device into the USB port.**
- 4 Switch the media mode of this unit to the media to be played using the timer.**
- 5 Set the audio timer for the desired times.**
 - Refer also to the owner's manual of the audio timer.
- 6 Turn the timer "On".**
 - The power of the components connected to the timer turns off.
 - When the set time is reached, the power of the different components automatically turns on and playback starts from the first track.

NOTE

- The timer play does not support the random playback or program playback.



Setting the Auto Standby mode

When Auto Standby mode is set to On, if the unit remains in the stopped state and no operations are performed for approximately 30 minutes, the unit automatically switches to standby mode.

Auto Standby mode is set to off by default.

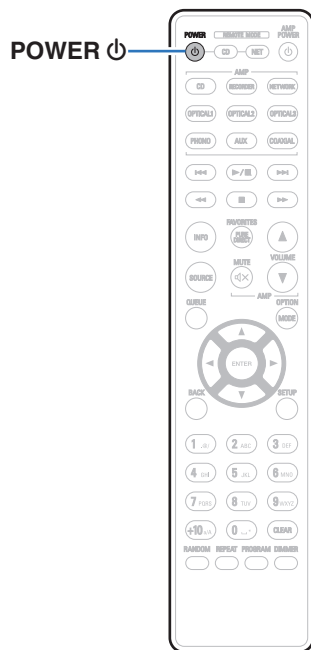

Turning Auto Standby mode on

- 1 Press and hold **POWER**  for more than 5 seconds to turn the Auto Standby mode on.

“AUTO STANDBY ON” appears on the display.

Turning Auto Standby mode off

- 1 Press and hold **POWER**  for more than 5 seconds to turn the Auto Standby mode off.

“AUTO STANDBY OFF” appears on the display.



■ Contents

Tips

I want to enjoy analog output audio at higher quality	39
I want to playback just the specified folder	39
I want to randomly play back all tracks on a CD-R/CD-RW or USB memory device	39

Troubleshooting

Power does not turn on / Power is turned off	41
Operations cannot be performed through the remote control unit	42
Display on this unit shows nothing	42
No sound comes out	43
Sound is interrupted or noise occurs	43
Cannot playback Discs	44



Tips

I want to enjoy analog output audio at higher quality

- Switch pure direct mode to “PURE DIRECT ON MODE2”. (👉 p. 26)

I want to playback just the specified folder

- Press the MODE button to set the playback mode to folder playback mode. (👉 p. 32), (👉 p. 35)

I want to randomly play back all tracks on a CD-R/CD-RW or USB memory device

- Random playback can be set by pressing the MODE button and setting all tracks playback mode as the playback mode before playback. (👉 p. 32), (👉 p. 35)



Troubleshooting

If a problem should arise, first check the following:

1. Are the connections correct?
2. Is the set being operated as described in the owner's manual?
3. Are the other devices operating properly?

If this unit does not operate properly, check the corresponding symptoms in this section.

If the symptoms do not match any of those described here, consult your dealer as it could be due to a fault in this unit. In this case, disconnect the power immediately and contact the store where you purchased this unit.



Power does not turn on / Power is turned off

Power is not turned on.

- Check whether the power plug is correctly inserted into the power outlet. (🔍 p. 22)
- This unit is in standby mode. Press the POWER ⏻ button on the remote control. (🔍 p. 24)

Power automatically turns off.

- The auto standby mode setting is on. The auto standby mode automatically switches the unit to standby if there are no operations for more than 30 minutes. To disable the Auto Standby mode, press and hold the POWER ⏻ button on the remote control for more than 5 seconds when the Auto Standby mode is enabled. (🔍 p. 37)



Operations cannot be performed through the remote control unit

Operations cannot be performed through the remote control unit.

- Batteries are worn out. Replace with new batteries. (🔧 p. 5)
- Operate the remote control unit within a distance of about 23 ft/7 m from this unit and at an angle of within 30°. (🔧 p. 5)
- Remove any obstacle between this unit and the remote control unit.
- Insert the batteries in the proper direction, checking the ⊕ and ⊖ marks. (🔧 p. 5)
- The unit's remote control sensor is exposed to strong light (direct sunlight, inverter type fluorescent bulb light, etc.). Move the set to a place in which the remote control sensor will not be exposed to strong light.
- When using a 3D video device, the remote control unit of this unit may not function due to effects of infrared communications between units (such as TV and glasses for 3D viewing). In this case, adjust the direction of units with the 3D communications function and their distance to ensure they do not affect operations from the remote control unit of this unit.

Display on this unit shows nothing

Display is off.

- Press the DIMMER button, and change the setting to anything other than off. (🔧 p. 25)
- When Pure Direct mode is set to "PURE DIRECT ON MODE1" or "PURE DIRECT ON MODE2", the display turns off. Press the PURE DIRECT button on the remote control to set "PURE DIRECT OFF". (🔧 p. 26)



No sound comes out

No sound is produced. Or sound is distorted.

- Check the connections for all devices. (👉 p. 17)
- Insert connection cables all the way in.
- Check that input connectors and output connectors are not reversely connected.
- Check cables for damage.
- Check the amplifier's functions and controls and adjust as necessary.
- Digital audio output stops during playback of the DSD files.
- Set the Pure Direct mode to "PURE DIRECT ON MODE2" to stop digital audio output. To output digital audio, turn off Pure Direct or set the Pure Direct mode to "PURE DIRECT ON MODE1". (👉 p. 26)

Sound is interrupted or noise occurs

During playback from the CD-R/CD-RW, sound is occasionally interrupted.

- This may be caused by poor recording conditions, or the disc itself may be of poor quality. Use a correctly recorded disc.

Sound is occasionally interrupted during playback from the USB memory device.

- When the transfer speed of the USB memory device is slow, sound may occasionally be interrupted.



Cannot playback Discs

Cannot playback when the play button is pressed, or cannot correctly play back a specific part of the disc.

- The disc is dirty or scratched. Either clean the disc, or insert a different disc. (🔍 p. 51)

Cannot playback CD-R/CD-RW.

- Discs cannot be played back unless they have been finalized. Use a finalized disc. (🔍 p. 45)
- This may be caused by poor recording conditions, or the disc itself may be of poor quality. Use a correctly recorded disc.
- Files are created in a format that is not supported by this unit. Check the formats supported by this unit. (🔍 p. 45)

“NO DISC” is displayed.



- “NO DISC” is displayed if the disc is loaded upside-down or if no disc is loaded. (🔍 p. 50)

“UNSUPPORTED” is displayed.

- “UNSUPPORTED” is displayed if a disc that cannot be played is loaded. (🔍 p. 50)



Playing back Discs

Playable media	
CD	
CD-R	
CD-RW	

NOTE

- Some discs and some recording formats cannot be played.
- Non-finalized discs cannot be played.

Files

■ Specifications of supported files

	Sampling frequency	Bit rate	Extension
MP3	32/44.1/48 kHz	48 – 320 kbps	.mp3
WMA	32/44.1/48 kHz	48 – 320 kbps	.wma

■ Maximum number of playable files and folders

Maximum number of folders : 256

Total number of folders and files : 512



NOTE

- Be sure to give files the extension. Files with any other extensions or files with no extensions cannot be played.
- Recordings you have made should only be used for your personal enjoyment, and as per copyright laws may not be used in other ways without permission of the copyright holder.



- Only music files that are not copyright-protected can be played on this unit.
 - Content downloaded from pay sites on the Internet are copyright protected. Also, files encoded in WMA format when ripped from a CD, etc. on a computer may be copyright protected, depending on the computer's settings.
- The maximum number of files and folders that can be played differs depending on conditions such as the length of the file name or folder name or the number of levels in the folder hierarchy.



Playing back a USB memory devices

- This unit is compatible with MP3 ID3-Tag (Ver. 2) standard.
- This unit is compatible with WMA META tags.
- If the image size (pixels) of an album artwork exceeds 500 × 500 (WMA/MP3/Apple Lossless/DSD) or 349 × 349 (MPEG-4 AAC), then music may not be played back properly.

■ Specifications of supported files

	Sampling frequency	Bit rate	Extension
WMA*1	32/44.1/48 kHz	48 – 320 kbps	.wma
MP3	32/44.1/48 kHz	48 – 320 kbps	.mp3
WAV	32/44.1/48/88.2/ 96/176.4/192 kHz	–	.wav
MPEG-4 AAC*1	32/44.1/48 kHz	48 – 320 kbps	.aac/.m4a/.mp4
FLAC	32/44.1/48/88.2/ 96/176.4/192 kHz	–	.flac
Apple Lossless*2	32/44.1/48/88.2/96 kHz	–	.m4a
AIFF	32/44.1/48/88.2/ 96/176.4/192 kHz	–	.aif/.aiff
DSD	2.8/5.6 MHz	–	.dsf/.dff

*1 Only files that are not protected by copyright can be played on this unit.
Content downloaded from pay sites on the Internet are copyright protected. Also, files encoded in WMA format when ripped from a CD, etc. on a computer may be copyright protected, depending on the computer's settings.

*2 The Apple Lossless Audio Codec (ALAC) is distributed under the Apache License, Version 2.0 (<http://www.apache.org/licenses/LICENSE-2.0>).



■ Maximum number of playable files and folder

The limits on the number of folders and files that can be displayed by this unit are as follows.

Item	Media	USB memory device
Number of folder directory levels *1		8 levels
Number of folders		255
Number of files*2		65025

*1 The limited number includes the root folder.

*2 The allowable number of files may differ according to the USB memory device capacity and the file size.

NOTE

- Digital audio output stops during playback of the DSD files.



Playback order of files

When there are multiple folders containing music files, the playback order of folders is automatically set when this unit reads the media. The files in each folder are played in alphabetical order.

CD-R/CD-RW and USB memory device

For playback of files on CD-R, CD-RW or USB memory device, files in all folders on the first layer are played first, next on the second layer, then next on the third layer, and so on in this order.



- The playback order displayed on a PC may differ from the actual playback order.
- The playback order with a CD-R/CD-RW may differ, depending on the writing software.

NOTE

- The playback order may differ from the order in which the folders or files were recorded if you delete or add a folder or file on USB. This occurs because of data recording specifications and is not a malfunction.

About folders and files

Music files recorded on CD-R/-RW and USB memory device are divided into large segments (folders) and small segments (files).

Files are stored in folders, and folders can be placed for storage in a hierarchy. The unit can recognize up to 8 levels of folders.

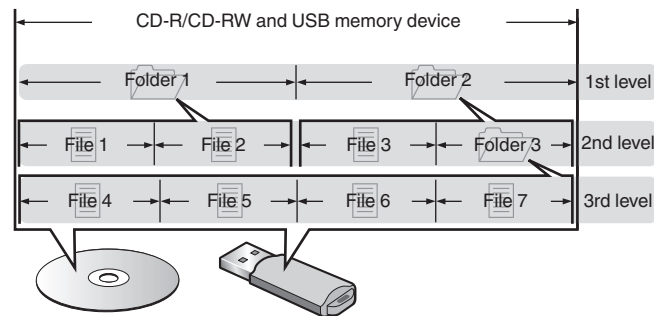

- When writing music files on a CD-R/-RW disc, set the writing software's format to "ISO9660". The files may not play properly if they are recorded in other formats. For details, refer to the instructions of your writing software.



Cautions on using media

Loading discs

- Set the disc in the tray label side up.
- Make sure the disc tray is fully open when inserting the disc.
- Place the discs flatly, 5 inch/12 cm discs in the outer tray guide (Figure 1), 3 inch/8 cm discs in the inner tray guide (Figure 2).

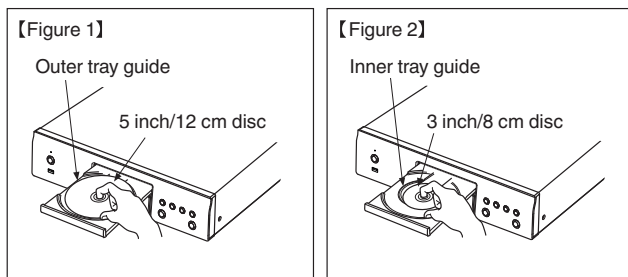

- Place 3 inch/8 cm discs in the inner tray guide without using an adapter.



- “UNSUPPORTED” is displayed if a disc that cannot be played is loaded.
- “NO DISC” is displayed if the disc is loaded upside-down or if no disc is loaded.

NOTE

- Only load one disc at a time. Loading two or more discs can damage the unit or scratch the discs.
- Do not use cracked or warped discs or discs that have been repaired with adhesive, etc.
- Do not use discs on which the sticky part of cellophane tape or labels is exposed or on which there are traces of where labels have been removed. Such discs can get caught inside the player and damage it.
- Do not use discs in special shapes, as they may damage the unit.



- Do not push the disc tray in by hand when the power is off. Doing so could damage the unit.
- If the unit is left in a room full of smoke from cigarettes, etc., for long periods of time, the surface of the optical pickup may get dirty, preventing it from receiving signals properly.



How to handle media

- Do not get fingerprints, oil or dirt on discs.
- Take special care not to scratch discs when removing them from their cases.
- Do not bend or heat discs.
- Do not enlarge the hole in the center.
- Do not write on the labeled (printed) surface with ball-point pens, pencils, etc., or stick new labels on discs.
- Condensation may form on discs if they are moved suddenly from a cold place (outdoors for example) to a warm place, but do not try to dry discs with a hairdryer, etc.
- Do not eject a USB memory device or turn off the unit while a USB memory device is being played. This may result in malfunction or loss of the USB memory device's data.
- Do not attempt to open or modify a USB memory device.
- USB memory device and files can be damaged by static electricity. Do not touch the metal contacts of a USB memory device with your fingers.
- Do not use warped USB memory device.
- After use, be sure to remove any disc or USB memory device, and store it in its proper case, to avoid dust, scratches and deformation.
- Do not store discs in the following places:
 1. Places exposed to direct sunlight for long periods of time
 2. Dusty or humid places
 3. Places exposed to heat from heaters, etc.

Cleaning discs

- If there are fingerprints or dirt on a disc, wipe them off before using the disc.
- Use a commercially available disc cleaning set or a soft cloth to clean discs.



Gently wipe the disc from the inside towards the outside.



Do not wipe with a circular motion.

NOTE

- Do not use record spray, antistatic agents, benzene, thinner or other solvents.



Explanation of terms

Advanced AL32 Processing Plus

Equipped with Advanced AL32 Processing Plus, Denon's own analog waveform reproduction technology. The reproducibility of weak signals is enhanced by expanding 16 bit digital data to 32 bit.

AIFF (Audio Interchange File Format)

This is an uncompressed and lossless format for digital audio. Use AIFF files to burn high-quality audio CDs from imported songs. AIFF files use approximately 10 MB of disk space per minute.

ALAC (Apple Lossless Audio Codec)

This is a codec for lossless audio compression method developed by Apple Inc. This codec can be played back on iTunes, iPod or iPhone. Data compressed to approximately 60 – 70 % can be decompressed to exactly the same original data.

DSD (Direct-Stream Digital)

One of the audio data recording methods, it is the signal aspect used to store audio signals on a super audio CD, and is Δ - Σ modulated digital audio.

FLAC

FLAC stands for Free lossless Audio Codec, and is a lossless free audio file format. Lossless means that the audio is compressed without any loss in quality.

The FLAC license is as shown below.

Copyright (C) 2000, 2001, 2002, 2003, 2004, 2005, 2006, 2007, 2008, 2009 Josh Coalson

Redistribution and use in source and binary forms, with or without modification, are permitted provided that the following conditions are met:

- Redistributions of source code must retain the above copyright notice, this list of conditions and the following disclaimer.
- Redistributions in binary form must reproduce the above copyright notice, this list of conditions and the following disclaimer in the documentation and/or other materials provided with the distribution.
- Neither the name of the Xiph.org Foundation nor the names of its contributors may be used to endorse or promote products derived from this software without specific prior written permission.



THIS SOFTWARE IS PROVIDED BY THE COPYRIGHT HOLDERS AND CONTRIBUTORS "AS IS" AND ANY EXPRESS OR IMPLIED WARRANTIES, INCLUDING, BUT NOT LIMITED TO, THE IMPLIED WARRANTIES OF MERCHANTABILITY AND FITNESS FOR A PARTICULAR PURPOSE ARE DISCLAIMED. IN NO EVENT SHALL THE FOUNDATION OR CONTRIBUTORS BE LIABLE FOR ANY DIRECT, INDIRECT, INCIDENTAL, SPECIAL, EXEMPLARY, OR CONSEQUENTIAL DAMAGES (INCLUDING, BUT NOT LIMITED TO, PROCUREMENT OF SUBSTITUTE GOODS OR SERVICES; LOSS OF USE, DATA, OR PROFITS; OR BUSINESS INTERRUPTION) HOWEVER CAUSED AND ON ANY THEORY OF LIABILITY, WHETHER IN CONTRACT, STRICT LIABILITY, OR TORT (INCLUDING NEGLIGENCE OR OTHERWISE) ARISING IN ANY WAY OUT OF THE USE OF THIS SOFTWARE, EVEN IF ADVISED OF THE POSSIBILITY OF SUCH DAMAGE.

MP3 (MPEG Audio Layer-3)

This is an internationally standardized audio data compression scheme, using the "MPEG-1" video compression standard. It compresses the data volume to about one eleventh its original size while maintaining sound quality equivalent to a music CD.

WMA (Windows Media Audio)

This is audio compression technology developed by Microsoft Corporation.

WMA data can be encoded using Windows Media® Player.

To encode WMA files, only use applications authorized by Microsoft Corporation. If you use an unauthorized application, the file may not work properly.

Sampling frequency

Sampling involves taking a reading of a sound wave (analog signal) at regular intervals and expressing the height of the wave at each reading in digitized format (producing a digital signal).

The number of readings taken in one second is called the "sampling frequency". The larger the value, the closer the reproduced sound is to the original.

Dynamic range

The difference between the maximum undistorted sound level and the minimum discernible level above the noise emitted by the device.



Bit rate

This is the amount of audio data recorded on a disc that is read in one second.

Finalizing

This process enables DVD/CD recorded with a recorder to be played by other players.

Linear PCM

This is an uncompressed PCM (Pulse Code Modulation) signal. Unlike lossy compression audio sources such as MP3, no audio quality or dynamic range deteriorates.

Trademark information



Adobe, the Adobe logo and Reader are either registered trademarks or trademarks of Adobe Systems Incorporated in the United States and/or other countries.



Specifications

■ Audio section

- Analog output

	[DSD]	[PCM]
Channels:	2-channel	2-channel
Playable frequency range:	2 Hz – 100 kHz	2 Hz – 96 kHz (sampling frequency: 192 kHz) 2 Hz – 20 kHz (sampling frequency: 44.1 kHz)
Playable frequency response:	2 Hz – 50 kHz (-3 dB)	2 Hz – 50 kHz (-3 dB) (sampling frequency: 192 kHz) 2 Hz – 20 kHz (sampling frequency: 44.1 kHz)
S/N:	115 dB (Audible range)	115 dB
Dynamic range:	108 dB (Audible range)	108 dB (24 bits) 101 dB (16 bits)
Harmonic distortion:	0.0015 % (Audible range)	0.0020 % (24 bits) 0.0025 % (16 bits)
Output level:	2.2 V RMS	2.2 V RMS



- **Optical readout system**

Laser:	AlGaAs
Wave length:	780 nm
Signal type:	16-bit linear PCM
Sampling frequency:	44.1 kHz

- **Digital output**

Coaxial:	0.5 Vp-p / 75 Ω /ohms
Optical :	-15 – -21 dBm

- **Digital input**

USB:	USB Type A (USB 2.0 High speed)
-------------	---------------------------------

■ General

Power supply:	AC120 V, 60 Hz
Power consumption:	28 W
Power consumption in standby mode:	0.2 W

For the purpose of improvement, the specifications and design are subject to change without notice.



■ Dimensions (Unit : in. (mm))

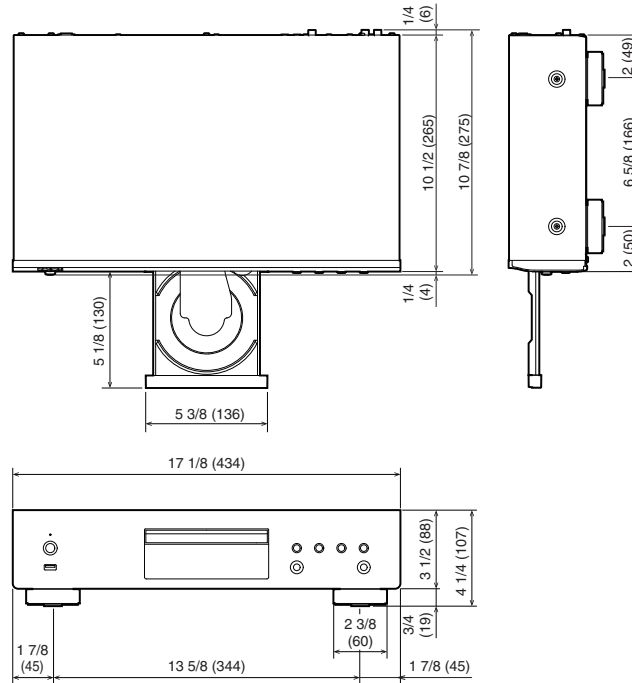

■ Weight : 9 lbs 15 oz (4.5 kg)

Index

A		F		T	
Amplifier	18	Front panel	7	Timer device	21, 36
Auto Standby	37	P		Tips	39
AV receiver	19	Program playback	29	Troubleshooting	40
C		R		U	
CD	27	Rear panel	10	USB memory device	20, 33
D		Remote control unit	11		
D/A converter	19				
DATA CD	30				
Display	9				
Display's brightness	25				



DENON®

3520 10630 00AD

Copyright © 2018 D&M Holdings Inc. All Rights Reserved.