

# audiolab

HOME AUDIO

FOR THE CONNOISSEUR



# audiolab

In brief...	
Founded in	1983
Founders	Philip Swift & Derek Scotland
Country of Origin	England
Brand Portfolio	Hi-Fi, Home Cinema Electronics and Loudspeakers
Price Range	Electronics - GBP400 to GBP1500
Philosophy	Aspire to be the epitome of high performance sound quality with attractive design. We are committed to simplifying functionality for the modern day music lover yet retaining purity of sound for the discerning audiophile.
Product Range	Omnia, 6000 Series, 8300 Series, M-DAC Series, M-EAR, DC BLOCK



## 6000N Play

*"Proof you needn't spend loads to acquaint your system with great-sounding streaming."*

What Hi-Fi? Awards 2020, *Product of the year - Music streamers*

What Hi-Fi? Awards 2020, *Best music streamers*

*"Insightful and involving... a great, affordable way to implement streaming into your system."*

What Hi-Fi? Awards 2019, *Product of the year - Music streamers*

What Hi-Fi? Awards 2019, *Best music streamers*

*"Quite frankly, it's the best budget [streaming] solution we've had the pleasure of meeting."*

What Hi-Fi? 5-star Review

## 6000A

*"A hugely capable stereo amplifier... clear, refined and articulate sound... big, spacious presentation."*

What Hi-Fi? 5-star Review



# Brand Mission

**audiolab** aspires to be the epitome of high performance sound quality with attractive design.

*Committed to simplifying functionality for the modern day music lover  
yet retaining purity of sound for the discerning audiophile.*



HOME AUDIO FOR THE CONNOISSEUR

# The Experts

## Jan Ertner, *Lead engineer audiolab electronics*

---

2015 sees the launch of **audiolab**'s brand new **8300** Series. With a long working relationship with **audiolab**, world renowned audio designer Jan Ertner has headed up the design of the **6000** series.

*"I have designed audio products for more than 25 years and still get excited about bringing new products to market. The joy of listening to music drives me and knowing that our customers will be able to enjoy it at its best is very satisfying. I believe in every product I design because I don't stop working until I feel myself saying "I want one" , that is the moment when I know it's right."*



## Peter Comeau, *Head of IAG acoustic design*

---

**audiolab** Hi-Fi products are supervised by IAG acoustic director Peter Comeau. His experience within the Hi-Fi industry spans over 40 years, and is an invaluable asset to **audiolab** in achieving the purest sound, fantastic value for money and a thrilling user experience.

# Awards

audiolab is proudly recognised by the hi-fi press world-wide for outstanding sound quality and usability.

- 
- 2008** Home Cinema Choice Awards 2008 - Best Buy Award  
Hi Fi & Records - Editor's Choice Award
- 2009** Hi Fi Plus - POY 2009 Highly Commended Award  
Hi Fi World - 5-Globes Award
- 2010** WHF? Sound and Vision - 5-Stars Award  
WHF? Sound and Vision - Product of the Year (CD Player)  
WHF? Sound and Vision - Group Test Winner  
Hi Fi Choice - Recommended Award and 5 stars  
TechRadar
- 2011** Hi Fi Choice Awards 2011-Product of the Year  
Hi Fi Choice - Recommended Award  
Hi Fi Choice -5 stars Award  
Hi Fi Choice Awards 2011 -Best Amplifier  
Hi Fi Choice Awards 2011 -Best CD Player  
WHF? Sound and Vision - 5-Stars Award(first tests)  
Hi Fi Choice - Recommended Award  
Hi Fi Choice -5 stars Award  
WHF? Sound and Vision - Product of the Year (CD Player)  
WHF? Sound and Vision - 5-Stars Award(first tests)  
Hi Fi World - 5-Globes Award  
Hi Fi Choice - Recommended Award  
WHF? Sound and Vision - Product of the Year  
WHF? Sound and Vision - 5-Stars Award  
Hi Fi Choice-5 stars Award  
WHF? Sound and Vision - Ultimate Guide to New Tech
- 2012** Hi Fi World - 4-Globes Award  
Hi Fi News-Group Test  
Hi Fi Choice -5 stars Award  
BBS Music Magazine - 5 Stars and product of year  
Hi Fi Choice -5 stars Award  
Hi Fi Choice -Editor's Choice  
Home Cinema Choice Best Buy  
WHF? Sound and Vision - Best Digital Headphone Amp  
WHF? Sound and Vision - Top 5 New Launches  
WHF? Sound and Vision - 5-Stars Award  
Hi Fi World - 4-Globes Award  
Hi Fi News-OUTSTANDING PRODUCT  
Best DAC, Hi-Fi Choice Awards 2012  
Product of the Year, Hi-Fi Choice Awards 2012
- 2013** Hi-Fi Choice Group test winner  
Hi-Fi Choice Group test winner  
Hi Fi Choice -5 stars Award  
Hi Fi Choice - Recommended Award  
Hi Fi World - 5-Globes Award  
Hi Fi Choice - Recommended Award  
Hi Fi Choice -5 stars Award
- 2014** What Hi-Fi Award 2014 - Best DAC 500-700 GBP
- 2015** WHF? Sound and Vision - Best Laptop System  
Hi-Fi World – 5 Globes Award  
Hi-Fi Choice - Recommended  
Hi-Fi Choice – Recommended
- 2016** Hi-Fi World - 5 Globes Award  
Hi-Fi News - Highly Commended  
Hi-Fi World - 5 Globes Award  
WHF - 5 Stars Test Winner  
Hi-Fi Choice - Recommended  
Gramophone - Product Of The Month  
Hi-Fi Choice - Recommended  
Hi-Fi World - 5 Globes Award
- 2017** avforums - Best Hi-Fi Amplifier 2017  
Hi-Fi World - 5 Globes Award  
Hi-Fi Choice - Recommended  
Hi-Fi Choice - Editor's Choice
- 

The audiolab logo is positioned in the bottom left corner of the page. It features the brand name 'audiolab' in a clean, lowercase, sans-serif font. The logo is white and stands out against the dark grey background of the left sidebar.

# Awards (cnt)

2018	avforums - Best Buy Award	M-DAC Mini	2019	Stereo & Video Magazine - 5 Stars Outstanding	8300CDQ
	WHF? Sound and Vision - 5 Stars Award	6000A		Hi-Fi Choice - 5 Stars Award	8300CDQ
	Hifi Pig - 5 Stars Outstanding Product	6000A & 6000CDT		What Hi-Fi - 5 Stars	M-DAC nano
	lite Das Lifestyle & Technik Magazin - Outstanding (middle class category)	6000A		What Hi-Fi? - Music Streamer of the Year	6000N Play
	AUDIO.de Magazine - Recommended (price, performance)	6000A		What Hi-Fi? - 5 Stars Award	6000N Play
	WHF - 5 Stars	6000A		Hi-Fi Choice - Recommended	6000N Play
	Hi-Fi Choice - Recommended	M-EAR		AUDIO.de Magazine - Good & Affordable	6000N Play
	Hi-Fi World - 5 Globes	M-EAR		Soundstage! Access - Reviewer's Choice	6000A
	Outstanding Amongst The Best	8300 CDQ		Hi-Fi Choice - Recommended	M-DAC+
	Hi-Fi Choice	6000 Series		What Hi-Fi? - Best DAC £100-£200	M-DAC nano
2019	Hi-Fi Voice Magazine - 10 Stars Recommended	6000 Series	What Hi-Fi? - 5 Stars Award	M-DAC nano	
	Gramophone - Product Of The Month	6000 Series	Hi-Fi Choice - Yearbook 2019	6000A	
	WEKA Media Publishing GmbH - Golden Ear 2019 (amplifier category below 2000€)	6000A	Hi-Fi Choice - Yearbook 2019	6000CDT	
	Hi-Fi News - Outstanding Products	6000A	Hi-Fi Choice - Yearbook 2019	8300CDQ	
	Hi-Fi Choice - Group Test Winner	6000A	Hi-Fi Choice - Yearbook 2019	M-DAC+	
	Hi-Fi World - 5 Globes	6000A	Hi-Fi Trends - Recommended Components	6000A Play	
	Outstanding Amongst The Best	6000A	Hi-Fi World - 5 Globes Outstanding Amongst The Best	6000A Play	
	Hi-Fi Choice - Editor's Choice	6000A	Hi-Fi Trends - Product Of The Year 2019	6000N Play	
	Hi-Fi Choice - Recommended	6000CDT	Hi-Fi Choice - Yearbook 2019	6000N Play	
	Hi-Fi Choice - Recommended	8300CDQ	Trusted Reviews -5 Stars Highly Recommended	6000N Play	
Avforums - Recommended	M-DAC nano	What Hi-Fi? - Best music streamers 2020	6000N Play		
lite Das Lifestyle & Technik Magazin - Outstanding (middle class category)	M-DAC nano	What Hi-Fi? - Product of the Year 2020	6000N Play		
		StereoNET UK - Applause Award	M-DAC nano		
		Trusted Reviews - Highly Recommended	M-DAC nano		
		2021	AVForums (UK) - Recommended	6000A Play	
			Hi-Fi World - 5 Globes Outstanding Amongst The Best	DC BLOCK	

# audiolab



## The All Encompassing Audio Solution

Blurring the lines that generally differentiate hi-fi and lifestyle, **Omnia** brings all of the pedigree that helps make **audiolab** electronics the connoisseur's choice. Yet, indulgence in design, material aesthetics and useability means it has all of the functionality to make it a sleek, convenient and easy-to-use centre-piece, for an uncompromising home audio system.

The **audiolab Omnia** maintains the award-winning, an instantly recognisable, **audiolab** design cues; Unfussy yet striking in appearance, the curved, brushed aluminium chassis is 'typical **audiolab**' but evolved to suit the modern-day living environment. **Omnia** is attractive but discreet, offering the perfect balance for living rooms and listening rooms alike.

In a world where music is more available than ever and sources more varied than ever, **Omnia** doesn't discriminate. However you listen to your music, **Omnia** has got you covered. To sum it up, the **audiolab Omnia** is a CD player, integrated amplifier, wireless streaming player, DAC, headphone amplifier and pre-amplifier - in one single unit!

## High-Performance CD Drive

Extremely robust and reliable; the **Omnia's** CD drive builds on the class-leading 6000CDT CD transport with a read-ahead digital buffer to reduce disc-reading failures. Such is the performance of this CD mechanism, **Omnia** is able to play scratched and damaged CDs that are unreadable by conventional mechanisms.



# Omnia



## Connectivity Options for Traditional Audio Sources

Utilising high-quality analogue preamp circuitry, akin to the acclaimed audiolab 6000 series, coupled to line-level RCA inputs to connect analogue sources, the preamp circuitry is kept as simple as possible. Using high-quality components to maintain signal purity, with line input signals passing to a precision analogue volume stage, **Omnia** is an outstanding pre-amp, in its own right.

A dedicated MM phono input means a turntable can be directly connected to **Omnia** via a high-quality, low-noise, phono stage with precise RIAA equalisation. This phono stage continues the evolution from the award-winning 6000 series - engineered to make the most of the music nestling within an LP's grooves.

## Networked Audio Playback

For networked audio playback, the **audiolab Omnia** is equipped with an ethernet port, lending itself to a wired connection and the wider bandwidth requirements of high-resolution digital audio.

For the most convenient access to wireless music playback, **Omnia** offers Bluetooth connectivity with high-quality, low latency, with the Bluetooth aptX standard.

The **Omnia's** Wi-Fi networking is powered by DTS Play-Fi: an app-controlled platform enabling high-quality, whole-home wireless audio, capable of streaming hi-res music up to 24-bit/192kHz and supported by a greater range of established audio brands than any other wireless platform.

# audiolab



## USB DAC Section & More

The USB DAC section is based upon audiolab's long-term partner, and multi-award-winning, pedigree. The new ES9038Q2M SABRE<sup>32</sup> Reference DAC performs D/A conversion, utilising ESS Technology's 32-bit HypersStream II architecture and Time Domain Jitter Eliminator to deliver ultra-low noise and high dynamic range.

No company knows more about making the most of this technically excellent, but challenging, DAC technology than audiolab; the universally acclaimed M-DAC was one of the first home audio components to incorporate an ESS chip back in 2011, and the company has been honing its implementation ever since.

## Master Quality Authenticated (MQA)

Via the USB DAC section, the audiolab Omnia also offers full decoding of MQA. MQA is an award-winning British technology that delivers the sound of the original master recording. The Omnia includes MQA decoder technology, which enables you to play back MQA audio files and streams - received via the USB input - at the original file's full resolution and passes the signal through its DAC and preamp stages. MQA files are available via subscription to TIDAL's 'HiFi' tier (among other sources).

*Visit [mqa.co.uk](http://mqa.co.uk) for more information.*

# Omnia



## Roon Tested

Further to this, the audiolab Omnia is also Roon tested, thus opening up to the world of Roon. Roon's fundamental goal is to provide a consistently stellar user experience. This goal doesn't stop at the software... the experience extends all the way down to the audio playback hardware, regardless of manufacturer. As a Roon Tested partner, audiolab has provided equipment to Roon for testing with a variety of different operating systems and computers, and shared information about its design and capabilities. We have a direct relationship with Roon and in many cases, the Roon support team has our devices on hand, so you can confidently choose to use audiolab hardware with Roon.

*Visit [roonlabs.com](http://roonlabs.com) for more information.*

## Connect With Zero Complexity

Simply connect your passive speakers to the audiolab Omnia and you have access to a world of audio sources with impeccable playback. The discrete Class AB power amp stage delivers 50W per channel into 8 ohms, with a maximum current delivery of 9 Amps, into difficult loads. The output stage of the discrete power amp circuits uses a CFB (Complementary Feedback) topology, ensuring superior linearity and excellent thermal stability, as the idle current is kept independent of the temperature of the output transistors. A substantial 200VA toroidal transformer, followed by 4x15,000uF reservoir capacity (60,000uF in total), helps the amp to maintain firm control of the music whilst enabling excellent dynamic range. More than just a class-leader, the Omnia is a class-beater in terms of amplifier performance!



DTS Play-Fi® App



Lossless Audio Streaming



Interactive GUI



Easy Setup



ESS Sabre32 DAC

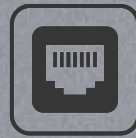

Ethernet Connection



Multi-room



Wi-Fi® Technology



Any Operating System

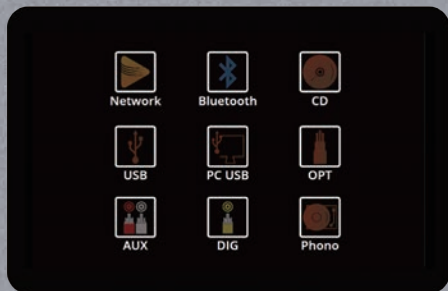

Source Options



VU Digital



VU Analogue

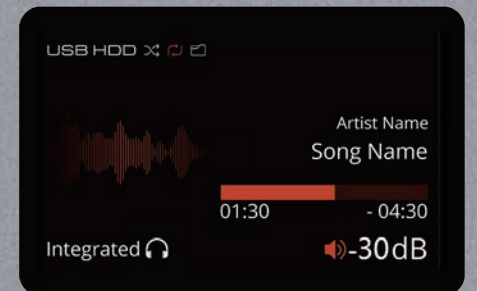

Playback Display

# Omnia

All-in-one Music System

# Omnia

## Like To Use Headphones

For those using headphones, as well as speakers, incorporates a dedicated headphone amp with current-feedback circuitry. Its gain bandwidth and high slew rate ensure a dynamic, detailed and engaging performance with all manner of headphone types – more boxes ticked for this most all-in-one of all-in-one systems!

## IPS LC Display

Firmly planting itself as a very useable piece of high-tech equipment, the **audiolab Omnia** makes use of a colour IPS LCD display, offering a higher clarity of colour and lower power consumption than TFT displays. Via the captivating display, the **audiolab Omnia** offers a simplified general user interface and a graphical integration with your music source and playback formats.

It also uses a brand new protocol for a real-time VU meter display, adding a touch of hi-fi finesse to the very functional, equally good looking, display interface.



ROON  
TESTED

MQA

DTS  
play-fi

Hi-Res  
AUDIO

Bluetooth®

aptX  
CSR

audiolab

# Omnia

All-in-one Music  
System

# Omnia

## Key Features

- **One for all**  
A complete integrated stand-alone all-in-one music solution
- **Lifestyle and pedigree**  
Encompassing a universal selection of playback options, Omnia offers it all:
  - CD playback
  - Full DAC and preamp facilities
  - Analog and digital source connectivity
  - Powerful stereo amplification
  - Dedicated headphone amplifier
  - Hi-res streaming via Wi-Fi or Ethernet
  - Major streaming service support (Spotify, Tidal, Qobuz, Amazon and more!)
  - Internet Radio
  - Multi-room compatibility
- **Own the digital domain**  
The 32-bit enabled, ES9038Q2M SABRE<sup>32</sup> DAC offers audiophile quality with ultra-low power consumption, and supports the industry's most popular high-resolution and lossless audio formats including MQA, FLAC, ALAC, AIFF and WAV as well as compressed legacy formats.



audiolab

# Omnia

All-in-one Music  
System

audiolab

# Omnia

## Key Features

- **MQA, all day, every day**

The Omnia includes MQA technology, which enables you to play back MQA audio files and streams, delivering the sound of the original master recording.

*Visit [mqa.co.uk](http://mqa.co.uk) for more information.*



- **Roon Tested**

Being Roon Tested means that audiolab and Roon have collaborated to ensure you have the best experience using Roon software and audiolab equipment together, so you can just enjoy the music.

*Visit [roonlabs.com](http://roonlabs.com) for more information.*



- **All on display**

A 4.3-inch display offers an interactive and graphic general user interface experience.

- **On the meter**

Omnia's standout display offers specifically developed digital VU meters.

- **Inputs**

4x S/PDIF digital audio (2x optical; 2x coaxial)

4x analogue audio (3x line level; 1x MM phono)

1 x power amp input

USB 2.0 port (replays stereo from compatible host)

CD playback (compatible with CD, CD-R, CD-RW discs)

- **Outputs**

Speaker binding posts

Headphone output

Preamp output

12V trigger





# Omnia

All-in-one Music System



Available in Silver and Black

## SPECIFICATIONS

Model	Omnia
General Description	Integrated Amplifier
Design Philosophy and Core Technology	<ul style="list-style-type: none"> <li>- 2x50W (8ohm) / 2x75W (4ohm) Class AB</li> <li>- ES9038Q2M 32-bit DAC</li> <li>- 4.3" (800x480mm) large size full view IPS LCD</li> <li>- Built-in certified hardware MQA Full decoder (PC USB, Coax, Optical)</li> <li>- CD playback compatible with CD, CD-R, CD-RW discs</li> <li>- USB memory device support (MP3/WMA/AAC/WAV)</li> <li>- DTS Play-Fi technology (IEEE 802.11 a/b/g/n/ac)</li> <li>- Streaming service support includes Amazon Music, Spotify, TIDAL, KKBox, SiriusXM, Napster, Internet Radio, Deezer, iHeartRadio, PANDORA, Qobuz, QQmusic and more</li> <li>- Multi-room / multi speaker group support</li> <li>- Bluetooth 5.0 (aptX/aptX LL) streaming</li> <li>- Low noise moving magnet phono stage</li> <li>- Dedicated current-feedback headphone amplifier</li> <li>- Integrated / PRE-POWER / PRE only modes</li> <li>- Android / iOS / Kindle Fire / Windows PC control support</li> <li>- USB firmware upgrade input</li> </ul>
Inputs	3 x Analogue, 1 x Phono (MM), 1 x Power Amplifier, 2 x SPDIF (Coax), 2 x SPDIF (Optical), 1 x DTS Play-Fi Streaming, 1 x PC USB (USB B), 1 x USB HDD (USB A), 1 x Bluetooth (aptX/aptX LL), 1 x 12V Trigger
Outputs	1 x PRE Amplifier, 1 x Stereo Speaker, 1 x Headphone, 1 x 12V Trigger
Sampling Frequency	Optical / Coaxial: 44.1kHz ---192kHz PC USB: 44.1kHz - 768kHz (PCM) / DSD64, DSD128, DSD256, DSD512
<b>Pre-amplifier Section</b>	
Gain	+8dB (Line) +47dB (Phono MM)
Input Sensitivity	720mV (Line, Volume = 0dB) 3.1mV (Phono MM, Volume = 0dB)
Input Impedance	10K (Line) 47K // 100pF (Phono MM)
Total Harmonic Distortion	< 0.0004% (1kHz @ 2V, Volume = 0dB)
Frequency Response	20Hz-20kHz (+/-0.1dB)
Output Voltage	2.3V max. (Volume = 0dB)
Output Impedance	100 ohm
Signal-to-Noise Ratio	> 110dB (Line, A-weighted) > 76dB (Phono MM, A-weighted)

Model	Omnia
<b>DAC</b>	
D to A Converter	ES9038Q2M
Total Harmonic Distortion	< 0.0006% (1kHz @ 0dBFS)
Output Level (0dBFS, 1kHz)	2.1Vrms
Max. Sampling Frequency	Optical, Coaxial: 192kHz Ethernet, Wi-Fi: 192kHz USB A: 48kHz PC USB: PCM768kHz, DSD512
Signal-to-noise Ratio (S/N)	> 114dB (A-weighted)
<b>Power Amplifier Section</b>	
Gain	+29dB
Rated Power Output	2 x 50W (8ohm, THD < 1%) 2 x 75W (4ohm, THD < 1%)
Frequency Response	20Hz-20kHz (+/-0.3dB)
Total Harmonic Distortion	< 0.003% (1kHz @ 40W / 8ohm)
Input Sensitivity	720mV
Signal-to-Noise Ratio (S/N)	> 110dB (A-weighted)
Max. Output Current	9A
<b>Headphone Amplifier</b>	
Total Harmonic Distortion	< 0.01% (1kHz, 50mW)
Output Impedance	10ohm
Load Impedance	20-600ohm
<b>General</b>	
Standby Power Consumption	< 0.5W
Net Weight	9.1kg
Gross Weight	11kg
Dimensions (mm) (W x H x D)	440 x 156 x 327
Carton Size (mm) (W x H x D)	540 x 412 x 210
Finishes	Black / Silver
Power Requirements (depending on region)	220-240V ~ 50/ 60Hz 100-120V ~ 50/ 60Hz
Standard Accessories	Power Cord, Remote Control, User Manual, Antennas, etc.

# DTS® Play-Fi®



## What is DTS Play-Fi®?

DTS Play-Fi is premium whole-home wireless audio, now available from the largest ecosystem of brands in the world. Stream your favorite content with astounding audio quality, from every device that you've got.

All DTS Play-Fi products are seamlessly interoperable, so you can find the perfect speaker for every room, and know that they will all make beautiful music together.



## Whole home audio, made easy:

DTS Play-Fi sends audio from mobile devices to speakers throughout the home using a proprietary streaming, synchronization, and authentication technology.

## Freedom of choice, at last

Every single DTS Play-Fi product works perfectly with all the rest, regardless of brand, so you get a huge range of options to customize your home, and one simple, elegant listening experience.

DTS Play-Fi offers an unparalleled selection of audio products for your home, from compact battery-powered speakers to powerful soundbars, built by the most respected audio brands in the business. No more compromising your style or taste to get a high-quality wireless audio solution.



## An endless supply of music

DTS Play-Fi comes with a wealth of music options from around the globe. Spotify, \*Pandora, Deezer, Napster, KKBox and Sirius XM, to name a few. Browse a radio guide with thousands of stations and podcasts, or stream from a home media server.

Stay tuned, because new services are added all the time.

*\* Pandora is enabled for select Play-Fi products only.*

## Works with every device you've got

Of course your music is always close by. And we know you have all kinds of devices in your life. That's why DTS Play-Fi is built especially for smartphones, tablets, and PCs.

We have easy-to-use software for **Android**, **iOS**, **Kindle Fires**, and **Windows**. We support streaming via Spotify Connect, too. Any way you want to play, it just works.

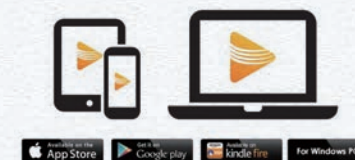

Wireless Streaming  
Technology

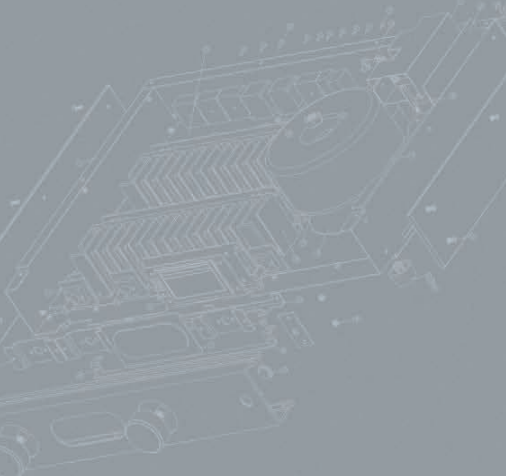

# audiolab

DTS® Play-Fi®



### What are Presets / Recents?

Presets within DTS Play-Fi are programmable buttons that allow you to quickly start up the content you want, pretty much like on a car stereo. We have a Presets section in the app that stores not only your content, but also your current speaker configuration, which you program yourself. "Recents" are the same, but these are automatically saved in the app separately based on your history of whatever you were last doing.

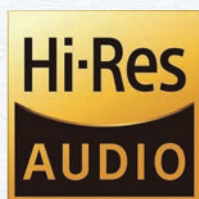
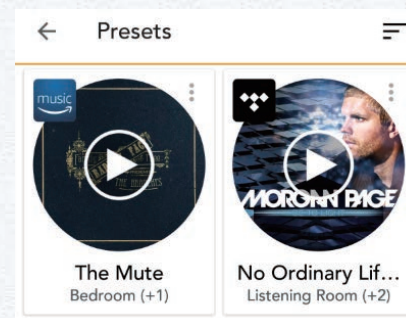

### Critical Listening

Want to sit down in a specific room and appreciate the fine subtleties of your high resolution audio collection? DTS Play-Fi has you covered.

Critical Listening mode allows you to send your high resolution audio files to your premium DTS Play-Fi product with no transcoding or downsampling, no wires necessary.

### A/V Synchronization

No longer do you need to suffer through the tiny speakers of your laptop or tablet when watching videos or YouTube. With the DTS Play-Fi app for \*Windows, turn on Video mode, and send the audio to the nearest DTS Play-Fi product to enjoy your video with premium sound wirelessly A/V synchronized.

\*requires Windows upgrade purchase <https://play-fi.com/apps/windows/>

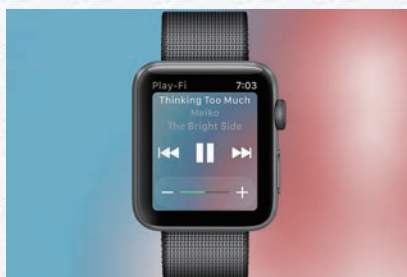
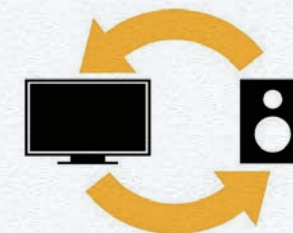

### More ways to control your music

We integrate with the software and hardware controls on your phone, tablet, or computer. Pause or seek through tracks in the notification or lock screen, or just leave the phone in your pocket and use the volume rocker to raise the noise throughout your house.

Got a smart watch? DTS Play-Fi can be controlled from both Android Wear and Apple Watch systems. Easily see what's playing at a glance, and quickly change up how the sessions going, without ever having to touch your phone.

### DTS Play-Fi Headphones

With the new DTS Play-Fi Headphones app, you can enjoy high quality TV audio privately through any pair of headphones.

Not only do you get the great sound quality and tight A/V synchronization of DTS Play-Fi, you can also connect to multiple headphones or speakers at the same time.

This app is only available on iOS and Android is coming soon!



Wireless Streaming Technology

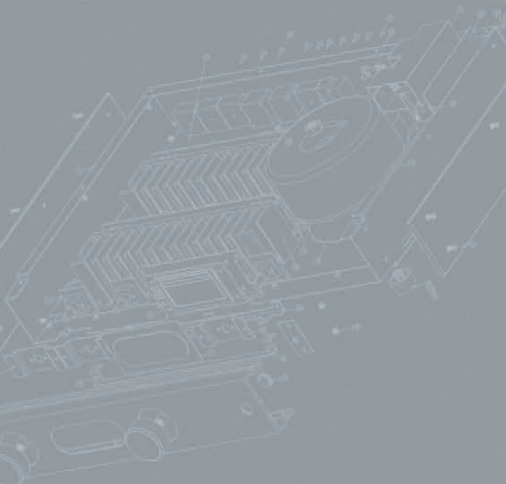

audiolab

DTS® Play-Fi®



*How DTS Play-Fi Stacks Up*

	DTS Play-Fi	Sonos	Airplay	Google Cast	Bluetooth
Android Compatible	●	●		●	●
iOS Compatible	●	●	●	●	●
Kindle Fire Compatible	●	●			‡
Play from any Application on a Windows PC	●				●
Dual-Band Wi-Fi	●		●	●	
Multi-Room, Expandable System (Synchronous)	●	●	†	●	
Multi-Zone Streaming from a Single Device	●	●		●	
Left/Right Stereo Speaker Pairing	●	●			
Lossless High-Resolution (24bit/192kHz) file playback	●				
Optional downsampling of Hi-Res content	●				
One Touch Music Station Presets	●				
Works with Alexa	●	●			
Modes for Synchronizing Audio with Video Source	●				
Wireless Surround Sound	●	●			
Stream from Device Inputs (Aux/Phono/HDMI/etc.)	●	●			
App-based Wireless Headphones	●				

† Plays to multiple rooms only from your iTunes collection running on a PC. Airplay cannot play to multiple rooms from your iPhone or iPad.

‡ This feature is only available on laptops/computers and Kindle Fire models with Bluetooth capabilities (e.g. Macs)

Wireless Streaming Technology

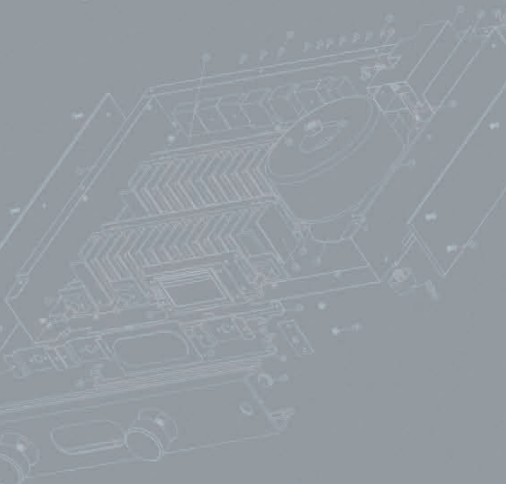

audiolab

6000  
series

6000 series



*Above: audiolab 6000A Play wireless audio streaming player paired with 6000CDT CD transport, in silver finishes.*

audiolab

6000  
series

wireless audio  
streaming  
player

# 6000A Play

## Future Proof, Unrivalled

A combination of the illustrious and class-leading 6000A integrated amplifier with the acclaimed 6000N Play wireless audio streaming player, the **audiolab 6000A Play** is a richly specified, all-encompassing audio solution.

Adapting to the modern world of music streaming but retaining all of the awarding winning analogue and digital audio circuitry from the 6000A, the **6000A Play** offers almost universal source compatibility.

The **audiolab 6000A Play** incorporates the acclaimed DTS Play-Fi® platform for built-in high resolution wireless streaming playback (up to 24-bit / 192kHz with compatible services such as TIDAL or Qobuz). You can stream from any source on your wireless network, including smart phones, tablets or PCs as well as a NAS Drive. So, however you want to play your music, **audiolab**'s **6000A Play** will deliver an outstanding performance.

The DTS Play-Fi platform offers a wealth of music options from around the globe. Spotify, Qobuz, Tidal, HD Tracks, Deezer, Amazon Music, Napster, KKBox and Sirius XM, to name a few. Browse a radio guide with thousands of stations and podcasts, or stream from a home media server with DLNA compatibility.

Above all, the **audiolab 6000A Play** offers flexibility without compromise. With deep, well-defined bass, expressive midrange and sweet, subtle treble – the **6000A Play** offers an open window on the music being played, as all great hi-fi should, engaging the listener with natural, unforced energy that is fully reflective of the source material.



audiolab

6000  
series

wireless audio  
streaming  
player

# 6000A Play

## Key Features

- Full analogue and digital circuitry retained from the award winning and class leading **audiolab 6000A** integrated amplifier with built-in wireless steaming technology
- Class AB power amplification: 2x50W into 8 ohms; 2x75W into 4 ohms aptX Bluetooth streaming
- ESS Sabre32 ES9018K2M Reference DAC - as seen in the award-winning **audiolab 6000A**
- Three user-selectable digital filters
- Class A post-DAC active filter
- Low noise JFET MM phono stage
- Dedicated current-feedback headphone amp
- Three operational modes - Integrated Mode; Pre-Power Mode; Pre Mode
- Ethernet connection - wired internet connection for high bandwidth applications
- Dedicated high performance MM phono input
- Separate pre-power sections for flexibility of operation
- Automatic equipment activation via 12V trigger
- Auto standby function



audiolab

6000  
series

wireless audio  
streaming  
player

# 6000A Play

## Key Features

- **Wi-Fi® Technology**  
DTS Play-Fi streams music over standard Wi-Fi networks, delivering perfectly synchronized audio, with no lag and zero loss in sound quality.
- **Lossless Audio Streaming**  
Stream in 24-bit/192kHz with compatible streaming services and files formats.
- **Multi-room**  
Enjoy music in every room of your house. All at once, perfectly synchronized, with no lag. You're in control.
- **DTS Play-Fi App**  
Simply download the free app and immediately send songs via Wi-Fi to any speaker in any room of the house.
- **Easy Setup**  
No logins, no complicated computer-based setups. Just download the app and within minutes, you're ready to listen.
- **Any Operating System**  
Fully compatible with all operating systems: Apple iOS, Android™, Windows® PC, and Fire OS.



DTS Play-Fi® App



Easy Setup



ESS Sabre32 DAC



Ethernet  
Connection



Lossless Audio  
Streaming



Multi-room



Wi-Fi® Technology



Any Operating  
System

audiolab



6000  
series

wireless audio  
streaming  
player



## SPECIFICATIONS

Available in Silver and Black

Model	6000A Play
DTS Play-Fi Technology	IEEE 802.11a/b/g/n/ac Supports global, popular streaming content (Amazon Music, Spotify, TIDAL, KKBox, SiriusXM, Napster, InternetRadio, Deezer, iHeartRadio, Pandora, SoundMachine, Qobuz, QQmusic) Supports Speaker Groups Supports Android/iOS/Kindle Fire/Windows PC Control
Analogue Inputs	3 x AUX, 1 x Phono (MM), 1 x Power In
Digital Input	2 x Coaxial, 2 x Toslink Optical, Bluetooth (aptX/aptX LL)
Analogue Output	1 x RCA Pre Out
Gain	+8dB (Line) +55dB (Phono MM)
Input Sensitivity	720mV (Line, Volume = 0dB) 3.1mV (Phono MM, Volume=0dB)
Input Impedance	10K (Line) 47K//100pF (Phono MM)
Total Harmonic Distortion (THD)	< 0.0004% (1KHz @ 2V, Volume = 0dB)
Frequency Response	20Hz-20kHz (+/-0.1dB)
Output Voltage	2.3V max. (Volume=0dB)
Output Impedance	120 ohm
Signal-to-Noise Ratio (S/N)	> 110dB (Line, A-weighted) > 76dB (Phono MM, A-weighted)
D To A Converter	ES9018K2M
Total Harmonic Distortion (THD)	< 0.0006% (1KHz @ 0dBFS)
Output Level (0dBFS, 1KHz)	2.05V
Max. Sampling Frequency	192KHz
Signal-to-noise ratio (S/N)	> 112dB (A-weighted)
Digital Filters	Fast Roll-off, Slow Roll-off, Minimum Phase
Gain	+29dB
Rated Max. Power Output	2 X 50W (8 ohm, THD<1%) 2 X 75W (4 ohm, THD<1%)
Frequency Response	20Hz-20kHz (+/-0.3dB)
Input Sensitivity	720mV (Volume=0dB)
Total Harmonic Distortion (THD)	< 0.003% (1kHz @ 40W/8ohm)
Signal-to-Noise ratio (S/N)	> 110dB (A-weighted)
Max. Output Current	9A
Total Harmonic Distortion (THD)	< 0.01% (1kHz, 10mW into 20ohm)
Output Impedance	2.35 ohm
Load impedance	20-600 ohm
Standby Power Consumption	< 0.5W
Power Requirements (depending on region)	220-240V ~ 50 - 60Hz 100-120V ~ 50 - 60Hz
Dimensions (mm) (W x H x D)	445 x 65.5 x 300mm
Weight	7.9kg (Net)

audiolab

6000  
series

# 6000 series



Above: **audiolab 6000N Play** wireless audio streaming player paired with **6000CDT** CD transport and **6000A** integrated amplifier, in silver finishes.

audiolab

6000  
series

wireless audio  
streaming  
player

# 6000N Play

## Play For Today

The **audiolab 6000N Play** is a wireless audio streaming player and is the latest member of the acclaimed **audiolab 6000 Series** of components.

Featuring DTS Play-Fi® Technology, music can be streamed over your wireless network in high resolution format and can be easily expanded to a multi-room system if required. You can stream from any source on your wireless network, including smart-phones, tablets or PCs as well as a NAS Drive.

The DTS Play-Fi platform offers a wealth of music options from around the globe. Spotify, Tidal, HD Tracks, Deezer, Amazon Music, Napster, KKBox and Sirius XM, to name a few. Browse a radio guide with thousands of stations and podcasts, or stream from a home media server with DLNA compatibility.

Taking technical elements from the coveted **audiolab 6000A** and **6000CDT**, however you want to stream your music, the **audiolab 6000N Play** will deliver an outstanding music streaming performance.

**WHAT HI-FI? AWARDS 2020, Product of the Year – Music streamers**

**WHAT HI-FI? AWARDS 2020, Best music streamer under £500**

**WHAT HI-FI? AWARDS 2019, Product of the Year – Music streamers**

**WHAT HI-FI? AWARDS 2019, Best music streamer under £500**



audiolab

6000  
series

wireless audio  
streaming  
player

# 6000N Play

## Key Features

- **Wi-Fi® Technology** - DTS Play-Fi streams music over standard Wi-Fi networks, delivering perfectly synchronized audio, with no lag and zero loss in sound quality
- **Any Operating System** - Fully compatible with all operating systems: Apple iOS, Android™, Windows® PC, and Fire OS
- **Easy Setup** - No logins, no complicated computer-based setups. Just download the app and within minutes, you're ready to listen
- **DTS Play-Fi App** - Simply download the free app and immediately send songs via Wi-Fi to any speaker in any room of the house
- **Multi-room** - Enjoy music in every room of your house — all at once, perfectly synchronized, with no lag. You're in control
- **Lossless Audio Streaming** - Stream in 24-bit/192kHz with compatible streaming services and files formats
- **ESS Sabre32 ES9018K2M Reference DAC** - As seen in the award-winning **audiolab 6000A**
- **Isolated Power Supply** - As seen in the award-winning **audiolab 6000CDT**
- **Ethernet Connection** - Wired internet connection for high bandwidth applications



DTS Play-Fi® App



Easy Setup



ESS Sabre32 DAC



Ethernet  
Connection



Lossless Audio  
Streaming



Multi-room



Wi-Fi® Technology



Any Operating  
System

audiolab

6000  
series

wireless audio  
streaming  
player



## SPECIFICATIONS

Available in Silver and Black

Model	6000N Play
<b>Digital Section:</b>	
Digital Output Level	500 +/- 50mVpp
Output Impedance	75 ohm
Maximum Resolution	192kHz/24bit
Digital Output	1 x coaxial , 1 x optical
<b>D to A Converter:</b>	
Variable Output Voltage	0 - 2.1V
DAC	ES9018K2M
Frequency Response	+/-0.5dB(20Hz-20kHz, ref.1kHz)
Total Harmonic Distortion (THD)	<0.003% (1kHz @0dBFS, BW=20-20kHz)
Signal-to-noise Ratio (S/N)	>115dB(A-weighted)
Analogue Output Impedance	100 ohm
Standby Power Consumption	<0.5W
Requirements (depending on region)	220V—240V~50/60Hz 100V—120V~50/60Hz
Dimensions (LxWxH)	445 x 313 x 65.5mm
Net Weight	4.9kg

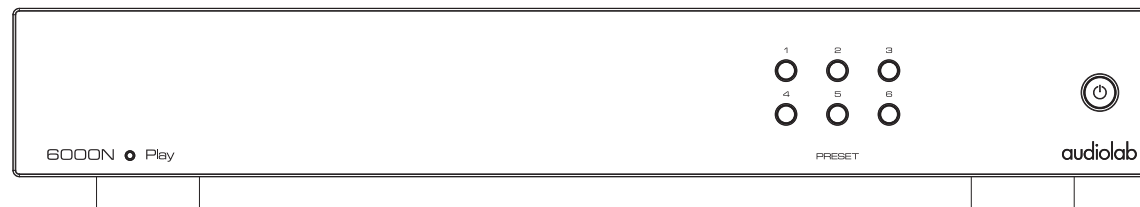

audiolab

6000  
series

integrated  
amplifier

# 6000A

## The Sound Of Science

The **6000A** integrated amplifier drives the **audiolab** philosophy to a new price-point while living up to today's world of audio expectations. Now home to the latest 32-bit DAC (ES9018K2M), with a Class AB amplifier capable of supplying 2x50W (8ohm) or 2x75W (4ohm) of clean power. The option of selecting between Integrated / PRE-POWER /PRE ONLY modes is available, depending on individual requirements.

To make the **6000A** as versatile as possible it comes with multiple Inputs: 3 x Analogue, 1 x Phono (Moving Magnet), 2 x SPDIF (Coax), 2 x SPDIF (Optical), 1 x Power Amplifier and Bluetooth (aptX) Technology.

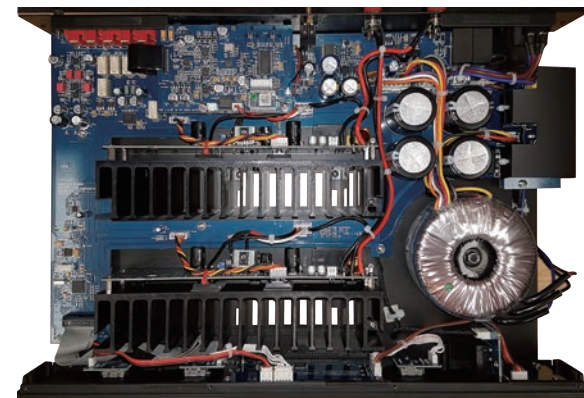

audiolab



6000  
series

integrated  
amplifier



Available in Silver and Black

## SPECIFICATIONS

Model	6000A
General Description	Integrated amplifier
Design Philosophy And Core Technology	Support Bluetooth(aptX) / Phono(MM) In / trigger in and link / filter selection / USB upgrade
Analogue Input	3 x RCA , 1 x RCA Phono(MM) , 1 x RCA POWER IN
Digital Input	2 x coaxial , 2 x optical, Bluetooth(aptX)
Variable Output Voltage	0 – 2.3V
Preamp Output Impedance	120 ohm
Frequency Response (Line)	20Hz-20kHz (+/-0.3dB)
Frequency Response (Phono)	20Hz-20kHz (+/-0.5dB)
Signal-to-noise Ratio (Line)	>110dB (A-weighted)
Signal-to-noise Ratio (Phono)	>76dB (A-weighted)
DAC	ES9018K2M
Total Harmonic Distortion (THD)	<0.0005% (1kHz @ 0dBFS)
Frequency Response	20Hz-20kHz (+/-0.3dB)
Signal-to-Noise Ratio (S/N)	>110dB (A-weighted)
Crosstalk	<80dB (@ 10kHz)
Standby Power Consumption	<0.5W
Dimensions ( W x H x D )	445 x 65.5 x 313 mm
Net Weight	7.9kg

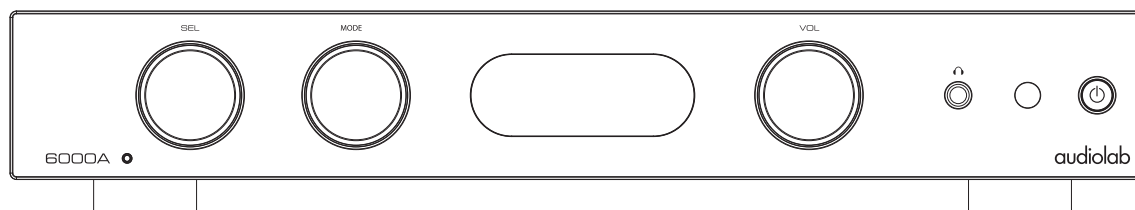

audiolab

6000  
series

CD  
transport

# 6000CDT

## audiolab's Latest CD Transport

The **6000CDT** is the latest CD transport from **audiolab**. Using **audiolab**'s slot loading mechanism, the transport uses read-ahead digital buffering to reduce disc reading failures and deliver the highest level of digital signal extraction from a wide range of CDs, even capable of reading scratched and damaged CDs that are unreadable by conventional mechanisms. The onboard digital decoder utilises digital coax and optical outputs to deliver the maximum versatility.



audiolab



6000  
series

CD  
transport



Available in Silver and Black

## SPECIFICATIONS

Model	6000CDT
General Description	CD Player
Digital Output Level	550+-50mVpp
Digital Output Impedance	75 ohm
Frequency Response	-0.01dB (20Hz-20kHz, ref.1kHz)
Total Harmonic Distortion	<0.001% (1kHz)
Signal-to-noise Ratio (S/N)	115dB
Sampling Rate	44.1kHz
Digital Output	1 x Coaxial , 1 x Optical
Standby Power Consumption	<0.5W
Dimensions (W X H X D )	445 x 65.5 x 300 mm
Net Weight	5.4kg
Power Requirements (depending on region)	220-230V ~ 50/ 60Hz 110-120V ~ 50/60Hz 100V ~50/60Hz

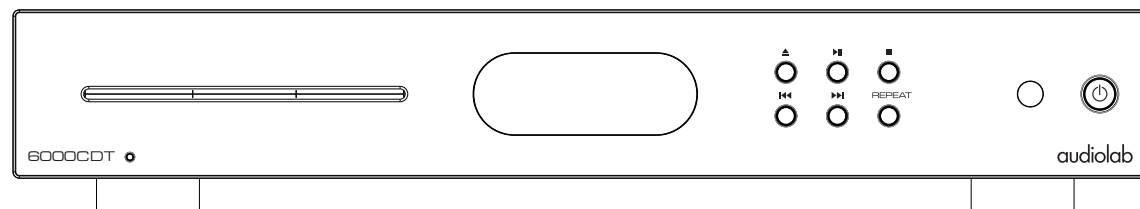

audiolab

8300  
series

8300 series



*Right: 8300A integrated amplifier paired with  
8300XP stereo power amplifier and 8300CDQ CD  
player*

audiolab

8300  
series

integrated  
amplifier

# 8300A

## Versatile High End Integrated Amplifier

The **8300A**'s circuit design delivers all-new sound quality. The soundstage it produces is deeper and broader, with greater space and separation within. Instrument and voices are better defined, their character is vividly portrayed. Dynamic range is greater and frequency response is further extended, with greater bass definition and treble that is both crisper and sweeter. In short, it delivers an open window on the music being played, as all great HiFi should, engaging the listener with natural, unforced energy that is fully reflective of the source material.

At this amplifier's heart is a powerful dual-mono amplifier delivering 75W per channel into eight ohms. CFB or 'Complementary Feedback' topology offers superior linearity and ensures excellent thermal stability.

ACD or 'Active Current Drive' means current limiting is under microprocessor control, programmed to allow the amplifier to supply high currents into complex loads, on par with amplifiers that are bigger and more powerful on paper.



audiolab

8300  
series

integrated  
amplifier



Available in Silver and Black

## SPECIFICATIONS

Model	8300A
General	Integrated amplifier
Description Design Philosophy And Core Technology	Dual mono power amp design
Display	OLED 128x64 pixels 2.7"
Controls	Logarithmic ladder volume circuit
Finish	Fine textured aluminium (black / silver)
Standby Features	Yes
12v Trigger	Yes
Phono	Yes (MM/MC)
Balanced XLR Input	Yes
<b>Pre-amplifier Section</b>	
Inputs	CD, video, tuner, aux 1, aux 2, XLR (balanced) & phono
Outputs	2 x RCA
Input Sensitivity (Phono RIAA)	3.4mV (MM), 340uV (MC)
Input Impedance (Line Inputs)	50K // 100pF
Input Impedance (Phono Inputs)	47K // 100pF (MM), 100R // 1.5nF (MC)
Input Voltage (Line)	3.5V max. (< 0.02% THD)
Output Voltage	2.3V max. (< 0.02% THD)
Preamp Output Impedance	120 ohm
Frequency Response (Line)	10Hz - 20kHz (+/- 0.1dB)
Frequency Response (Line)	1Hz - 100kHz (+/- 3.0dB)
Frequency Response (Phono RIAA)	20Hz - 20kHz (+/- 1.0dB)

audiolab

8300  
series

integrated  
amplifier

Model	8300A
Channel Imbalance	<0.2dB (10Hz - 20kHz)
Total Harmonic Distortion (THD) Line	<0.001%
Total Harmonic Distortion (THD) Phono	<0.002%
Signal-to-noise Ratio (Line)	>107dB >109dB (A-weighted)
Signal-to-noise Ratio Phono (MM)	>73dB >78dB (A-weighted)
Signal-to-noise Ratio Phono (MC) (Volume = 0db , Vin=300uV , Rs=0r, BW=20-20khz)	>68dB >73dB (A-weighted)
Crosstalk	<80dB (L-> R & R->L @10KHz)
<b>Power Amplifier Section</b>	
Gain	29dB (20Hz-20KHz)
Input Sensitivity	840mV (Power Out = 70W into 8ohm)
Input Impedance	15K // 100pF
Rated Max Power Output , Thd < 1%	2 x 75W RMS (8 ohm) , 2 x 115W (4 ohm) (Ref. Power Supply= 230V AC)
Peak Output Current	+/- 15A
Frequency Response	+/- 0.1dB (10Hz - 20KHz) +/- 3.0dB (1Hz - 100KHz)
Channel Imbalance	<0.2dB (10Hz - 20kHz)
Total Harmonic Distortion (THD)	<0.002% (Power Out = 50W @ 1KHz, BW = 20Hz - 20kHz)
Signal-to-noise Ratio	>107dB (BW = 20 - 20KHz ) >109dB(A-weighted BW = 20 - 20KHz)
Damping Factor	>100 (8ohm Load @ 1kHz)
Inputs	1 x RCA
Outputs	2 x Preamp
Dimensions	80 x 444 x 330.3mm
Weight	7.8kg

audiolab

8300  
series

CD  
player

# 8300CDQ

## Extra Value Added

An addition to the **8300CD** family, the **8300CDQ** adds full analogue preamp functionality. The existing digital inputs are joined by three line-level analogue inputs, providing source selection and volume control in the analogue domain. The preamplifier section is fully balanced and all analogue input signals are converted to balanced form, helping to reduce distortion and noise. Class A gain structures are present throughout, and users may choose between pre-amplification in the analogue or digital domain in respect of the digital inputs. The **8300CDQ** adds a direct-coupled, discrete, Class A headphone amplifier, accessible via a socket on the front panel.

**8300CDQ** includes MQA technology, which enables you to play back MQA audio files and streams, delivering the sound of the original master recording. MQA (Master Quality Authenticated) is an award-winning British technology that delivers the sound of the original master recording. The master MQA file is fully authenticated and is small enough to stream or download. Visit [mqa.co.uk](http://mqa.co.uk) for more information.



audiolab

*The MQA logo is a trademark of MQA Limited.*

8300  
series

CD  
player



Available in Silver and Black

## SPECIFICATIONS

Model	8300CDQ
General Description	CD player, digital-to-analogue converter
Disc Compatibility	CD / CDR, etc.
USB Audio Compatibility	Supports MQA decoding, 384k PCM and DSD256
DAC	ESS Sabre32 9018 chip
Resolution	32 bits
Sampling Frequency	Optical, coaxial, AES: 32kHz - 192kHz USB: 32kHz - 384kHz (PCM) / DSD64, DSD128, DSD256
Maximum Sampling Frequency	Optical, coaxial, AES: 192kHz USB: 384kHz (PCM) / 11.2M (DSD256)
Digital Input	2 x coaxial, 2 x toslink optical, 1 x USB for PC USB
Analogue Input	3 x AUX
Digital Output	1 x coaxial, 1 x toslink optical
Output Voltage	4.2Vrms $\pm$ 0.1 (balanced), 2.1Vrms $\pm$ 0.1 (unbalanced)
Output Impedance	10 ohm
Total Harmonic Distortion	<0.002%
Frequency Response	20Hz - 20kHz ( $\pm$ 0.2dB)
Signal-to-noise Ratio (S/N) A wtd	RCA: <98dB, XLR<100dB
Dynamic Range A wtd	RCA: >98dB, XLR>100dB
Crosstalk @1K	RCA: <-120dB, XLR<-130dB
Standby Power Consumption	<0.5W
Dimensions ( W x H x D )	444 x 80 x 317 mm
Net Weight	6.0kg

audiolab

8300  
series

stereo  
power  
amplifier

# 8300XP

## New Stereo Power Amplifier

The **8300XP** is a classic **audiolab** stereo power amplifier, with a sound as clean and crisp as its minimalist exterior. Its pedigree is impeccable, descended from a range of amplifiers revered throughout the world for their unerring ability to perform at the highest level.

Delivering 140W per channel into 8 Ohms, the **8300XP** is capable of driving even the toughest of loudspeakers with sure-footed authority, combining **audiolab**'s class-leading neutrality with an unerring ability to engage the listener throughout a musical performance. When listening to the **8300XP**, what you hear is the music - pure and unadulterated, with detail and dynamic range fully intact.

## Sound Optimization

Exemplary build quality and reliability ensure that this is a power amp for all seasons, its versatility increased by a choice of balanced XLR and single-ended RCA inputs, bi-wire speaker terminals and a pair of 12v trigger Inputs. Internal circuit components are of the highest quality, right down to the power and signal wiring, which is made of ultra-pure OCC (Ohno Continuous Cast) copper - all in aid of minimising distortion whilst maximising sonic clarity.

Flexibility is further enhanced by the ability to add a second **8300XP** and operate in a bridged mode, thus increasing the power output to 480W per channel into 8 Ohms. All **audiolab** amplifiers are gain-matched, ensuring perfect integration with other **audiolab** components - so you can start at the level that suits you best, and build up your system over time.



audiolab



8300  
series

stereo  
power  
amplifier



Available in Silver and Black

## SPECIFICATIONS

Model	8300XP
Rated	140W RMS (8 ohm <1% THD,1kHz stereo) 230W RMS (4 ohm <1% THD,1kHz stereo) 480W RMS (8 ohm <1% THD,1kHz bridge)
Gain	29dB @ 1kHz (stereo) 36dB @ 1kHz (bridge)
Input Sensitivity	1100mV
Input Impedance	15K (balanced) 10K (unbalanced)
Frequency Response	20Hz - 80kHz (-3dB) 20Hz - 30kHz (+/-1dB)
Total Harmonic Distortion (THD)	0.004% (20W, ref. 1kHz)
Intermodulation Distortion (IM)	0.004% (20W, ref. 7kHz+60Hz)
Transient Intermodulation Distortion (TID)	113dB (A Weighted, ref. 140W)
Signal-to-noise Ratio (S/N)	140W / 113dB
Damping Factor	160
Power Requirement	240V~50-60Hz 230V~50-60Hz 115V~50-60Hz 100V~50-60Hz
Dimension (W x H x D)	444 x 149 x 367 mm
Net Weight	16Kg

audiolab

8300  
series

mono  
power  
amplifier

# 8300MB

## Pure Power

The **8300MB** is quite possibly the perfect example of **audiolab's** goal to effortlessly reproduce music with exquisite detail. Not only is **8300MB** an extremely powerful amplifier, offering 250W of pure power with high current drive capability, but it also features a fully balanced power stage.

Internally the **8300MB** is arranged as two complete power amplifiers which are bridge coupled to the loudspeaker terminals. Each power amplification stage is fed from one of the terminals of the balanced input, therefore the **8300MB** operates as a fully balanced amplifier right through to the speaker output. The benefits are a high level of noise rejection and lower transient distortion plus the ability of the amplifier to draw maximum current from the power supply as required to follow the musical waveform accurately .

This all adds up to a startlingly vivid and highly impactful musical performance that will put more energy into your loudspeakers as well as control them like never before.



*Left: Two audiolab 8300MBs mono power amplifiers paired with 8300CD CD player in silver finish*

audiolab

8300  
series

mono  
power  
amplifier

audiolab



Available in Silver and Black

## SPECIFICATIONS

Model	8300MB
General Description	Mono power amplifier
Finish	Fine textured aluminium (black / silver)
Standby Feature	Yes
12V Trigger	Yes
<b>Power Amplifier Section</b>	
Power Output	250W RMS (8 ohm, <1% THD, 1kHz)
GAIN	29dB (8 ohm)
Inputs	RCA, XLR
Outputs	Speaker binding post terminal
Input Sensitivity	1500mV
Input Impedance	44kohm (balanced)
Outputs	22Kohm (unbalanced)
Power Bandwidth	5Hz - 60kHz
Frequency Response	20Hz - 20kHz (ref. 1kHz 0.1dB) 20Hz - 60kHz (ref. 1kHz -3dB)
Total Harmonic Distortion (THD)	0.003% (30W, ref. 1kHz)
Intermodulation Distortion (IM)	0.03% (30W, ref. 7kHz+60Hz)
Signal-to-Noise Ratio (S/N)	110dB (A Weighted, ref. 250W)
Damping Factor	200
Dimensions	150 x 216 x 370mm
Weight	9.5kg

# M-DAC series

digital-to-  
analogue  
lineup

## M-DAC+

- The new styling is in keeping with the new **8300** series industrial design making the **M-DAC+** a perfect companion for the **8300A** or or **8300XP**
- 32-bit ESS Sabre DAC
- Widely renowned as the best-sounding DAC available
- Similarly to the **8300CD**, the **M-DAC+** extends its frequency response to 384kHz via USB
- This is far higher than current hi-res formats, meaning it is equipped for future advances in digital audio
- USB A for iOS device playback and charging
- Same versatile PCM & DSD filters as **8300CD**
- 12v trigger connections
- Inputs: 2 x COAX, 2 x OPT, AES, USB A, USB B
- Outputs: 2 x Balanced XLR, 2 x RCA, OPT, COAX



audiolab



# M-DAC series

integrated  
amplifier



Available in Silver and Black

## SPECIFICATIONS

Model	M-DAC+
General Description	Digital-to-analogue converter
DAC	ESS Sabre32 9018 chip
Sampling Rate	24-bit / 192kHz (Optical, Coaxial, AES) 32-bit / 384kHz (USB) 2.8MHz (DSD64), 5.6MHz (DSD128), 11.2MHz (DSD256)
Digital Input	2 x Coaxial, 2 x Toslink Optical, 1 x AES/EBU, 1 x USB for PC USB, 1x USB for iPod/iPhone/iPad
Digital Output	1x Coaxial, 1 x Toslink Optical
Output Voltage	Balanced: 4.5Vrms $\pm$ 0.1 Unbalanced: 2.25Vrms $\pm$ 0.1
Output Impedance	10 ohm
THD (1kHz 0dB 20Hz - 20kHz A wtd)	<0.002%
Frequency Response	20Hz - 20KHz ( $\pm$ 0.2dB)
Signal-to-noise Ratio A Wtd	RCA: >115dB, XLR: >120dB
Dynamic Range A Wtd	RCA: >115dB, XLR: >120dB
Crosstalk @ 1k	RCA: <-120dB, XLR: <-130dB
Dimensions (mm)	114 x 247 x 292 mm
Net Weight	3.7kg

audiolab

# M-DAC series

digital-to-  
analogue  
converter

# M-DAC nano

## Small Yet Mighty

The latest addition to the **M-DAC** range continues this tradition. The **M-DAC nano** is the smallest, most affordable and most conveniently mobile **M-DAC** yet!

Similar in size to a small matchbox, the **M-DAC nano** is a brilliantly simple way to transform headphone sound quality when you are on the go. It connects wirelessly to Android phones, iPhones, tablets and more via Bluetooth, untethering the listener's headphones from the playback device – much more convenient for mobile use than DAC/headphone amps that require cables to connect.

And that is not the only thing that is wireless. The **M-DAC nano's** built-in battery supports Qi wireless charging – simply pop it on the supplied charging pad to deliver up to eight hours of playing time.

Of course, all this convenience would mean nothing if the **M-DAC nano's** sound quality was subpar – but **audiolab** has squeezed in plenty of tech to ensure it sounds great!



**WHAT HI-FI? AWARDS 2019, Best DAC £100-£200**



Model	M-DAC nano
Wireless Connectivity	Bluetooth V4.2
Output Power	30mW per channel @32 ohm (1Vrms output) 7.5mW per channel @300 ohm (1.5Vrms output)
Audio Codec	aptX / aptX LL / AAC / SBC
Matching Impedance	8Ω to 300 ohm
Dimensions	44 × 44 × 14mm
Weight	28g

audiolab

M-DAC  
series

digital-to-  
analogue  
converter

# M-DAC nano

## Usage And Benefits

- Turn your favourite corded headphones or earphones into Bluetooth ones – convenient for audio on the go.
- Digital upsampling tech, hi-res digital-to-analogue conversion and powerful amplification deliver enhanced sound quality compared to plugging headphones/earphones directly into phones, tablets, laptops etc.
- Bluetooth reception (with support for aptX, aptX Low Latency and AAC) means no more messing with USB OTG cables for Android devices and all the necessary cables/adapters for iOS devices, in contrast to portable DAC/headphone amps that require USB connection. Just pair and go!
- Advanced audio technology delivers superior sound quality compared to headphones / earphones with integrated Bluetooth.
- Great way to use corded phones with an iPhone without a headphone output – untethered from the iPhone and no Lightning adapter required!
- Can also be used to add high-quality Bluetooth reception to a home-based audio system – simply connect the **M-DAC nano's** 3.5mm headphone output to a 3.5mm 'aux' input or RCA-phono inputs (cable not supplied).

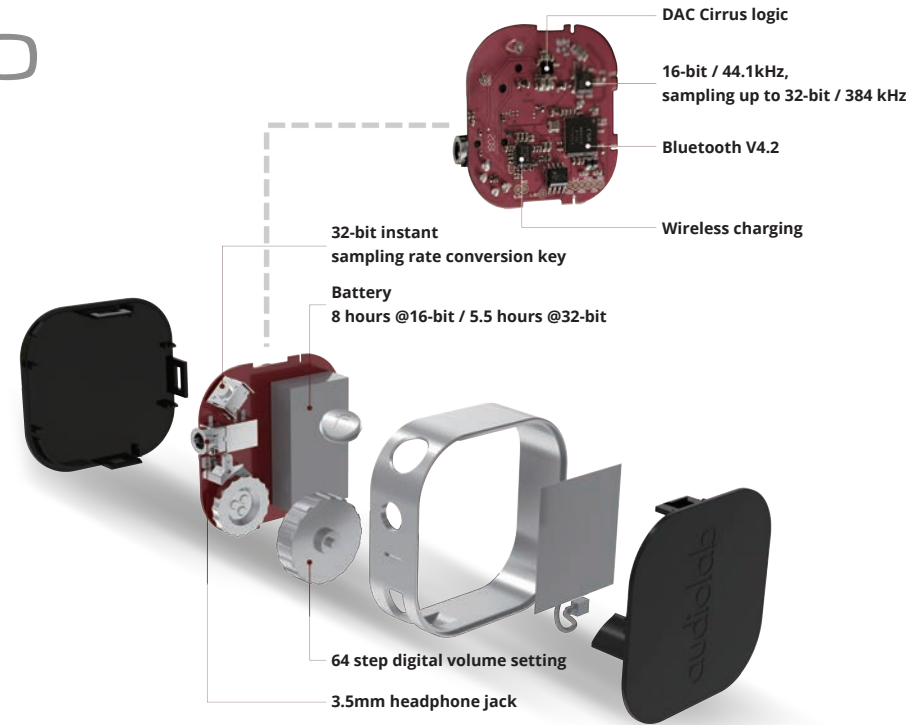

High Quality Audio



Wireless Charging



Ultra Light Weight  
& Compact



Built In Headphone  
Amplifier

audiolab

# DC BLOCK

Direct  
Current  
Blocker

# DC BLOCK

## Direct Current Blocker

The **audiolab DC BLOCK** utilises a simple connection and intelligent design that will help remove DC from your mains power supply, instantly. As well as DC removal, the **audiolab DC BLOCK** provides additional mains conditioning and RF filtering, of both common and differential mode noise, which further contributes to the optimal operation of your audio equipment.

The **audiolab DC BLOCK** mains conditioner is compatible with most audio equipment that utilises an IEC mains inlet and will offer a no-nonsense, instant improvement to the mains power supply, and ultimately, the performance of your Hi-Fi system.

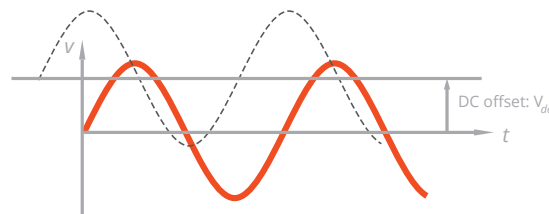

- ▶ Asymmetrical loads cause the waveform to be offset and result in what is known as 'DC on the mains'
- ▶ This typically manifests in 'noisy operation' and acoustically compromised performance

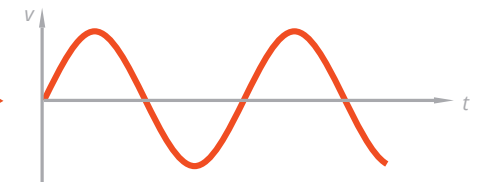
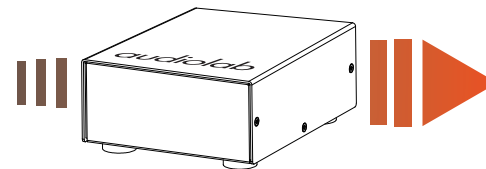

- ▶ DC is removed from the AC supply for a purer signal
- ▶ Transformer hum and other adverse effects are significantly reduced



# DC BLOCK

Direct  
Current  
Blocker

# DC BLOCK

## KEY FEATURES

- Removes DC from AC mains supply
- Reduces transformer hum
- Reduces RF interference
- Improves the performance of audio components



Available in Silver and Black

## SPECIFICATIONS

Model	DC BLOCK
Power Requirement	100-240V ~ 50-60Hz
Peak Load*	600VA
Audio Power Amplifier Compatibility	< 2x150W or < 1x300W
Dimension (W x H x D)	113 x 59 x140 (mm)
Weight (net)	0.7 kg

*\*Note: The audiolab DC BLOCK is designed for audio equipment with variable power requirements up to max. Peak Load and should not feed any permanent high power loads such as heaters or similar.*

audiolab

HEADPHONES  
series

reference  
grade in-ear  
headphones

# M-EAR



Little **M-EARs** deliver **BIG** music

**audiolab's M-EAR 2D and M-EAR 4D** – the brand's first headphones – are in-ear monitors that combine multiple balanced armature drivers to thrilling musical effect. Two celebrated names from the UK audio scene – **audiolab** and ACS – have teamed up to deliver a range of British-made, multi-driver in-ear monitors called **audiolab M-EAR**.

The **M-EAR 2D** is a two-way, two-driver design, with one driver handling mid/high frequencies and the other dedicated to bass. The **M-EAR 4D** is a three-way design sporting four drive units – one for high frequencies, another for midrange and two for bass.

An inline, ultra-high clarity microphone is included for convenience when making phone calls or recording.



audiolab

 Engineered &  
Made In The UK

reference  
grade in-ear  
headphones

# M-EAR

Little M-EARs deliver BIG music

Both M-EAR models incorporate balanced armature drivers, which differ from the dynamic drivers found in most headphones and earphones.

These drivers use an electronic signal to vibrate a tiny reed suspended between two magnets; this movement is transferred to an aluminium diaphragm that generates soundwaves. Balanced armature drivers deliver greater efficiency and are extremely compact, enabling several drivers to be combined in small, sound-isolating in-ear monitors.

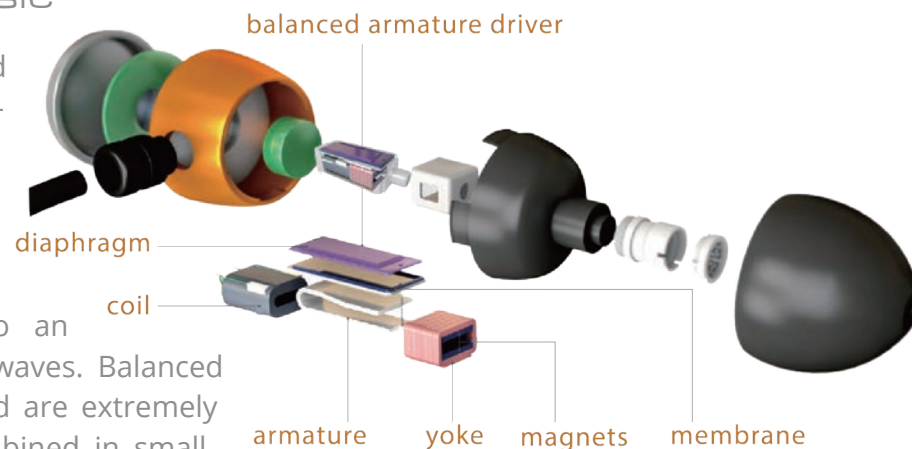

Model	M-EAR (2D)	M-EAR (4D)
Driver configuration	2 x balanced armature drivers	4 x balanced armature drivers
Crossover	Two-way system	Three-way system
Noise isolation	-26dB	-26dB
Frequency response	20Hz-20kHz	20Hz-20kHz
Impedance	112 Ohms (@1kHz)	66 Ohms (@1kHz)
Output (sensitivity)	112dB @ 0.1V (1kHz)	115dB @ 0.1V (1kHz)
Cable	1.45m detachable	1.45m detachable
In-line microphone	SiSonic™ MEMS	SiSonic™ MEMS
Accessories	6 x memory foam ear tips; carrying case	6 x memory foam ear tips; carrying case
Weight	20g	20.5g



Made In UK



Low Distortion,  
Maximum Efficiency



Precise Sound  
Reproduction



Enhanced Sonic  
Definition



Multi-Driver  
Design



True Record  
In-line Microphone



Engineered &  
Made In The UK

Omnia



6000 A Play



6000 A



6000 CDT



6000 N Play

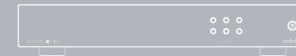

M-DAC+

M-DAC nano

8300 A



8300 CDQ



8300 XP

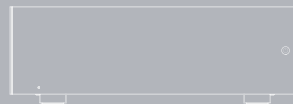

8300 MB



M-EAR

DC BLOCK

audiolab

[www.audiolab.co.uk](http://www.audiolab.co.uk) [audiolabiag](https://www.facebook.com/audiolabiag) [audiolabhifi](https://www.instagram.com/audiolabhifi)

IAG House, 13/14 Glebe Road, Huntingdon,  
Cambridgeshire, PE29 7DL, UK